



PROFESS¹ONAL
SERIES™

FATALITY
GAMING GEAR

ASRock®

X299 Gaming i9

User Manual

Version 1.0

Published June 2017

Copyright©2017 ASRock INC. All rights reserved.

Copyright Notice:

No part of this documentation may be reproduced, transcribed, transmitted, or translated in any language, in any form or by any means, except duplication of documentation by the purchaser for backup purpose, without written consent of ASRock Inc.

Products and corporate names appearing in this documentation may or may not be registered trademarks or copyrights of their respective companies, and are used only for identification or explanation and to the owners' benefit, without intent to infringe.

Disclaimer:

Specifications and information contained in this documentation are furnished for informational use only and subject to change without notice, and should not be constructed as a commitment by ASRock. ASRock assumes no responsibility for any errors or omissions that may appear in this documentation.

With respect to the contents of this documentation, ASRock does not provide warranty of any kind, either expressed or implied, including but not limited to the implied warranties or conditions of merchantability or fitness for a particular purpose.

In no event shall ASRock, its directors, officers, employees, or agents be liable for any indirect, special, incidental, or consequential damages (including damages for loss of profits, loss of business, loss of data, interruption of business and the like), even if ASRock has been advised of the possibility of such damages arising from any defect or error in the documentation or product.



This device complies with Part 15 of the FCC Rules. Operation is subject to the following two conditions:

- (1) this device may not cause harmful interference, and
- (2) this device must accept any interference received, including interference that may cause undesired operation.

CALIFORNIA, USA ONLY

The Lithium battery adopted on this motherboard contains Perchlorate, a toxic substance controlled in Perchlorate Best Management Practices (BMP) regulations passed by the California Legislature. When you discard the Lithium battery in California, USA, please follow the related regulations in advance.

“Perchlorate Material-special handling may apply, see www.dtsc.ca.gov/hazardouswaste/perchlorate”

ASRock Website: <http://www.asrock.com>

AUSTRALIA ONLY

Our goods come with guarantees that cannot be excluded under the Australian Consumer Law. You are entitled to a replacement or refund for a major failure and compensation for any other reasonably foreseeable loss or damage caused by our goods. You are also entitled to have the goods repaired or replaced if the goods fail to be of acceptable quality and the failure does not amount to a major failure. If you require assistance please call ASRock Tel : +886-2-28965588 ext.123 (Standard International call charges apply)



Fatal1ty Story

Who knew that at age 19, I would be a World Champion PC gamer. When I was 13, I actually played competitive billiards in professional tournaments and won four or five games off guys who played at the highest level. I actually thought of making a career of it, but at that young age situations change rapidly. Because I've been blessed with great hand-eye coordination and a grasp of mathematics (an important element in video gaming) I gravitated to that activity.

GOING PRO

I started professional gaming in 1999 when I entered the CPL (Cyberathlete Professional League) tournament in Dallas and won \$4,000 for coming in third place. Emerging as one of the top players in the United States, a company interested in sponsoring me flew me to Sweden to compete against the top 12 players in the world. I won 18 straight games, lost none, and took first place, becoming the number one ranked Quake III player in the world in the process. Two months later I followed that success by traveling to Dallas and defending my title as the world's best Quake III player, winning the \$40,000 grand prize. From there I entered competitions all over the world, including Singapore, Korea, Germany, Australia, Holland and Brazil in addition to Los Angeles, New York and St. Louis.

WINNING STREAK

I was excited to showcase my true gaming skills when defending my title as CPL Champion of the year at the CPL Winter 2001 because I would be competing in a totally different first person shooter (fps) game, Alien vs. Predator II. I won that competition and walked away with a new car. The next year I won the same title playing Unreal Tournament 2003, becoming the only three-time CPL champion of the year. And I did it playing a different game each year, something no one else has ever done and a feat of which I am extremely proud.

At QuakeCon 2002, I faced off against my rival ZeRo4 in one of the most highly anticipated matches of the year, winning in a 14 to (-1) killer victory. Competing at Quakecon 2004, I became the World's 1st Doom3 Champion by defeating Daler in a series of very challenging matches and earning \$25,000 for the victory.

Since then Fatal1ty has traveled the globe to compete against the best in the world, winning prizes and acclaim, including the 2005 CPL World Tour Championship in New York City for a \$150,000 first place triumph. In August 2007, Johnathan was awarded the first ever Lifetime Achievement Award in the four year history of the eSports-Award for "showing exceptional sportsmanship, taking part in shaping eSports into what it is today and for being the prime representative of this young sport. He has become the figurehead for eSports worldwide".

LIVIN' LARGE

Since my first big tournament wins, I have been a "Professional Cyberathlete", traveling the world and livin' large with lots of International media coverage on outlets such as MTV, ESPN and a 60 Minutes segment on CBS to name only a few. It's unreal - it's crazy. I'm living a dream by playing video games for a living. I've always been athletic and took sports like hockey and football very seriously, working out and training hard. This discipline helps me become a better gamer and my drive to be the best has opened the doors necessary to become a professional.

A DREAM

Now, another dream is being realized – building the ultimate gaming computer, made up of the best parts under my own brand. Quality hardware makes a huge difference in competitions...a couple more frames per second and everything gets really nice. It's all about getting the computer processing faster and allowing more fluid movement around the maps.

My vision for Fatal1ty hardware is to allow gamers to focus on the game without worrying about their equipment, something I've preached since I began competing. I don't want to worry about my equipment. I want to be there – over and done with - so I can focus on the game. I want it to be the fastest and most stable computer equipment on the face of the planet, so quality is what Fatal1ty Brand products represent.



Johnathan "Fatal1ty" Wendel



Contents

Chapter 1 Introduction	1
1.1 Package Contents	1
1.2 Specifications	2
1.3 Motherboard Layout	8
1.4 I/O Panel	10
Chapter 2 Installation	14
2.1 Installing the CPU	15
2.2 Installing the CPU Fan and Heatsink	18
2.3 Installation of Memory Modules (DIMM)	19
2.4 Expansion Slots (PCI Express Slots)	21
2.5 Jumpers Setup	23
2.6 Onboard Headers and Connectors	24
2.7 Smart Switches	30
2.8 Dr. Debug	31
2.9 SLI™, 3-Way SLI™ and Quad SLI™ Operation Guide	33
2.9.1 Installing Two SLI™-Ready Graphics Cards	33
2.9.2 Installing Three SLI™-Ready Graphics Cards	35
2.9.3 Driver Installation and Setup	37
2.10 CrossFireX™, 3-Way CrossFireX™ and Quad CrossFireX™ Operation Guide	38
2.10.1 Installing Two CrossFireX™-Ready Graphics Cards	38
2.10.2 Installing Three CrossFireX™-Ready Graphics Cards	40

2.10.3	Driver Installation and Setup	41
2.11	M.2_SSD (NGFF) Module Installation Guide	42
Chapter 3 Software and Utilities Operation		46
3.1	Installing Drivers	46
3.2	F-Stream	47
3.2.1	Installing F-Stream	47
3.2.2	Using F-Stream	47
3.3	ASRock Live Update & APP Shop	50
3.3.1	UI Overview	50
3.3.2	Apps	51
3.3.3	BIOS & Drivers	54
3.3.4	Setting	55
3.4	Creative SoundBlaster Cinema3	56
3.5	ASRock RGB LED	57
Chapter 4 UEFI SETUP UTILITY		59
4.1	Introduction	59
4.2	EZ Mode	60
4.3	Advanced Mode	61
4.3.1	UEFI Menu Bar	61
4.3.2	Navigation Keys	62
4.4	Main Screen	63
4.5	OC Tweaker Screen	64
4.6	Advanced Screen	80
4.6.1	CPU Configuration	81

4.6.2	Chipset Configuration	83
4.6.3	Storage Configuration	86
4.6.4	Super IO Configuration	88
4.6.5	ACPI Configuration	89
4.6.6	USB Configuration	90
4.6.7	Trusted Computing	91
4.7	Tools	92
4.8	Hardware Health Event Monitoring Screen	94
4.9	Security Screen	97
4.10	Boot Screen	98
4.11	Exit Screen	100

Chapter 1 Introduction

Thank you for purchasing ASRock Fatal1ty X299 Professional Gaming i9 Series motherboard, a reliable motherboard produced under ASRock's consistently stringent quality control. It delivers excellent performance with robust design conforming to ASRock's commitment to quality and endurance.

In this documentation, Chapter 1 and 2 contains the introduction of the motherboard and step-by-step installation guides. Chapter 3 contains the operation guide of the software and utilities. Chapter 4 contains the configuration guide of the BIOS setup.



Because the motherboard specifications and the BIOS software might be updated, the content of this documentation will be subject to change without notice. In case any modifications of this documentation occur, the updated version will be available on ASRock's website without further notice. If you require technical support related to this motherboard, please visit our website for specific information about the model you are using. You may find the latest VGA cards and CPU support list on ASRock's website as well. ASRock website <http://www.asrock.com>.

1.1 Package Contents

- ASRock Fatal1ty X299 Professional Gaming i9 Series Motherboard (ATX Form Factor)
- ASRock Fatal1ty X299 Professional Gaming i9 Series Quick Installation Guide
- ASRock Fatal1ty X299 Professional Gaming i9 Series Support CD
- 1 x I/O Panel Shield
- 1 x ASRock SLI_HB_Bridge_2S Card (Optional)
- 1 x ASRock 3-Way SLI-2S1S Bridge Card (Optional)
- 4 x Serial ATA (SATA) Data Cables (Optional)
- 2 x ASRock WiFi 2.4/5 GHz Antennas (Optional)
- 3 x Screws for M.2 Sockets (Optional)

1.2 Specifications

- Platform**
- ATX Form Factor
 - 8 Layer PCB
 - 2oz Copper PCB

- CPU**
- Supports Intel® Core™ X-Series Processor Family for the LGA 2066 Socket
 - Digi Power design
 - 13 Power Phase design
 - Supports Intel® Turbo Boost Max Technology 3.0
 - * Please note that the 4-Core processors only support Intel® Turbo Boost Technology 2.0.
 - Supports ASRock Hyper BCLK Engine III

- Chipset**
- Intel® X299

- Memory**
- Quad Channel DDR4 Memory Technology
 - 8 x DDR4 DIMM Slots
 - Supports DDR4 4400+(OC)*/4266(OC)/4133(OC)/4000(OC)/3866(OC)/3800(OC)/3733(OC)/3600(OC)/3200(OC)/2933(OC)/2800(OC)/2666/2400/2133 non-ECC, un-buffered memory
 - * The maximum memory frequency supported may vary by processor type.
 - * Please refer to Memory Support List on ASRock's website for more information. (<http://www.asrock.com/>)
 - Supports non-ECC RDIMM (Registered DIMM)
 - Max. capacity of system memory: 128GB
 - Supports Intel® Extreme Memory Profile (XMP) 2.0
 - 15µ Gold Contact in DIMM Slots

- Expansion Slot**
- 4 x PCI Express 3.0 x16 Slots*
 - * If you install CPU with 44 lanes, PCIE1/PCIE2/PCIE3/PCIE5 will run at x16/x8/x16/x0 or x8/x8/x16/x8.
 - * If you install CPU with 28 lanes, PCIE1/PCIE2/PCIE3/PCIE5 will run at x16/x0/x8/x0 or x8/x0/x8/x8.
 - * If you install CPU with 16 lanes, PCIE1/PCIE2/PCIE3/PCIE5 will run at x16/x0/x0/x0 or x8/x0/x4/x0.
 - * Supports NVMe SSD as boot disks
 - 1 x PCI Express 2.0 x1 Slot

- Supports AMD Quad CrossFireX™, 3-Way CrossFireX™ and CrossFireX™**

** 3-Way CrossFireX™ is only supported with CPU with 44 lanes or 28 lanes.

- Supports NVIDIA® Quad SLI™, 3-Way SLI™ and SLI™***

*** This feature is only supported with CPU with 44 lanes or 28 lanes.

- 1 x Vertical M.2 Socket (Key E) with the bundled WiFi-802.11ac module (on the rear I/O)
- 15μ Gold Contact in VGA PCIe Slot (PCIE1 and PCIE3)

Audio

- 7.1 CH HD Audio with Content Protection (Realtek ALC1220 Audio Codec)
- Premium Blu-ray Audio support
- Supports Surge Protection (ASRock Full Spike Protection)
- Nichicon Fine Gold Series Audio Caps
- 120dB SNR DAC with Differential Amplifier
- TI® NE5532 Premium Headset Amplifier for Front Panel Audio Connector (Supports up to 600 Ohm headsets)
- Pure Power-In
- Direct Drive Technology
- PCB Isolate Shielding
- Impedance Sensing on Front Out port
- Individual PCB Layers for R/L Audio Channel
- Gold Audio Jacks
- 15μ Gold Audio Connector
- Supports Creative SoundBlaster Cinema3

LAN

1 x 10 Gigabit LAN 100/1000/2500/5000/10000 Mb/s (AQUANTIA® AQC107):

- Supports Wake-On-LAN
- Supports Lightning/ESD Protection (ASRock Full Spike Protection)
- Supports PXE

2 x Gigabit LAN 10/100/1000 Mb/s (1 x Intel® I219V, 1 x Intel® I211AT):

- Supports Wake-On-LAN
- Supports Lightning/ESD Protection (ASRock Full Spike Protection)

- Supports Energy Efficient Ethernet 802.3az
- Supports PXE

Wireless LAN

- Intel® 802.11ac WiFi Module (Free Bundle)
- Supports IEEE 802.11a/b/g/n/ac
- Supports Dual-Band (2.4/5 GHz)
- Supports high speed wireless connections up to 433Mbps
- Supports Bluetooth 4.2 / 3.0 + High speed class II

Rear Panel I/O

- 2 x Antenna Ports
- 1 x PS/2 Mouse/Keyboard Port
- 1 x Optical SPDIF Out Port
- 2 x USB 2.0 Ports (Supports ESD Protection)
- * 1 x FatalIty Mouse Port (USB 2.0) is included
- 1 x USB 3.1 Type-A Port (10 Gb/s) (ASMedia ASM3142) (Supports ESD Protection (ASRock Full Spike Protection))
- 1 x USB 3.1 Type-C Port (10 Gb/s) (ASMedia ASM3142) (Supports ESD Protection (ASRock Full Spike Protection))
- * Ultra USB Power is supported on USB3_12 ports.
- * ACPI wake-up function is not supported on USB3_12 ports.
- 4 x USB 3.0 Ports (Supports ESD Protection (ASRock Full Spike Protection))
- 3 x RJ-45 LAN Ports with LED (ACT/LINK LED and SPEED LED)
- 1 x BIOS Flashback Switch
- 1 x Clear CMOS Switch
- HD Audio Jacks: Rear Speaker / Central / Bass / Line in / Front Speaker / Microphone (Gold Audio Jacks)

Storage

- 8 x SATA3 6.0 Gb/s Connectors, support RAID (RAID 0, RAID 1, RAID 5, RAID 10, Intel Rapid Storage Technology 15 and Intel Smart Response Technology), NCQ, AHCI and Hot Plug*
- * If M2_1 is occupied by a SATA-type M.2 device, SATA3_1 will be disabled.
- * If M2_2 is occupied by a SATA-type M.2 device, SATA3_0 will be disabled.

- * If M2_3 is occupied by a SATA-type M.2 device, SATA3_7 will be disabled.
- 2 x SATA3 6.0 Gb/s Connectors by ASMedia ASM1061, support NCQ, AHCI and Hot Plug
- 1 x Ultra M.2 Socket (M2_2), supports M Key type 2230/2242/2260/2280/22110 M.2 SATA3 6.0 Gb/s module and M.2 PCI Express module up to Gen3 x4 (32 Gb/s)**
- 2 x Ultra M.2 Sockets (M2_1 and M2_3), support M Key type 2230/2242/2260/2280 M.2 SATA3 6.0 Gb/s module and M.2 PCI Express module up to Gen3 x4 (32 Gb/s)**
- ** Supports Intel® Optane™ Technology
- ** Supports PCIe RAID (on M2_2 and M2_3)
- ** Supports NVMe SSD as boot disks
- ** Supports ASRock U.2 Kit

Connector

- 1 x Virtual RAID On CPU Header
- 1 x TPM Header
- 1 x Power LED and Speaker Header
- 2 x RGB LED Headers
- * Support up to 12V/3A, 36W LED Strip
- 1 x CPU Fan Connector (4-pin)
- * The CPU Fan Connector supports the CPU fan of maximum 1A (12W) fan power.
 - 1 x CPU Optional/Water Pump Fan Connector (4-pin) (Smart Fan Speed Control)
- * The CPU Optional/Water Pump Fan supports the water cooler fan of maximum 1.5A (18W) fan power.
 - 2 x Chassis Fan Connectors (4-pin) (Smart Fan Speed Control)
 - 1 x Chassis Optional/Water Pump Fan Connector (4-pin) (Smart Fan Speed Control)
- * The Chassis Optional/Water Pump Fan supports the water cooler fan of maximum 1.5A (18W) fan power.
- * CPU_OPT/W_PUMP, CHA_FAN1, CHA_FAN2 and CHA_FAN3/W_PUMP can auto detect if 3-pin or 4-pin fan is in use.
 - 1 x 24 pin ATX Power Connector (Hi-Density Power Connector)
 - 1 x 8 pin 12V Power Connector (Hi-Density Power Connector)

- 1 x Front Panel Audio Connector (15µ Gold Audio Connector)
- 1 x Thunderbolt AIC Connector (5-pin)
- * The Thunderbolt™ AIC card can be installed in the enabled PCIe slot (depending on CPU type).
- 2 x USB 2.0 Headers (Support 4 USB 2.0 ports) (Supports ESD Protection (ASRock Full Spike Protection))
- 2 x USB 3.0 Headers (Support 4 USB 3.0 ports) (ASMedia ASM1074 Hub) (Supports ESD Protection (ASRock Full Spike Protection))
- 1 x Front Panel Type C USB 3.1 Header (ASMedia ASM3142)
- * Supports USB PD 2.0 up to 12V@3A (36W) charging
- 1 x Dr. Debug with LED
- 1 x Power Switch with LED
- 1 x Reset Switch with LED

BIOS Feature

- 2 x AMI UEFI Legal BIOS with multilingual GUI support (1 x Main BIOS and 1 x Backup BIOS)
- Supports Secure Backup UEFI Technology
- ACPI 6.1 Compliant wake up events
- SMBIOS 3.0 Support
- CPU, DRAM, VPPM, VTTM, PCH 1.0V, VCCMPHY, VCCIO, VCCST, VCCSA, VCCSFR, VCCPLL, CLK VDD Voltage Multi-adjustment

Hardware Monitor

- Temperature Sensing: CPU, CPU Optional/Water Pump, Chassis, Chassis Optional/Water Pump Fans
- Fan Tachometer: CPU, CPU Optional/Water Pump, Chassis, Chassis Optional/Water Pump Fans
- Quiet Fan (Auto adjust chassis fan speed by CPU temperature): CPU, CPU Optional/Water Pump, Chassis, Chassis Optional/Water Pump Fans
- Fan Multi-Speed Control: CPU, CPU Optional/Water Pump, Chassis, Chassis Optional/Water Pump Fans
- Voltage monitoring: +12V, +5V, +3.3V, CPU Vcore, DRAM, PCH 1.0V, VCCIO, VCCSA, VCCSFR

OS

- Microsoft® Windows® 10 64-bit

**Certifica-
tions**

- FCC, CE
- ErP/EuP ready (ErP/EuP ready power supply is required)

* For detailed product information, please visit our website: <http://www.asrock.com>



Please realize that there is a certain risk involved with overclocking, including adjusting the setting in the BIOS, applying Untied Overclocking Technology, or using third-party overclocking tools. Overclocking may affect your system's stability, or even cause damage to the components and devices of your system. It should be done at your own risk and expense. We are not responsible for possible damage caused by overclocking.

1.3 Motherboard Layout

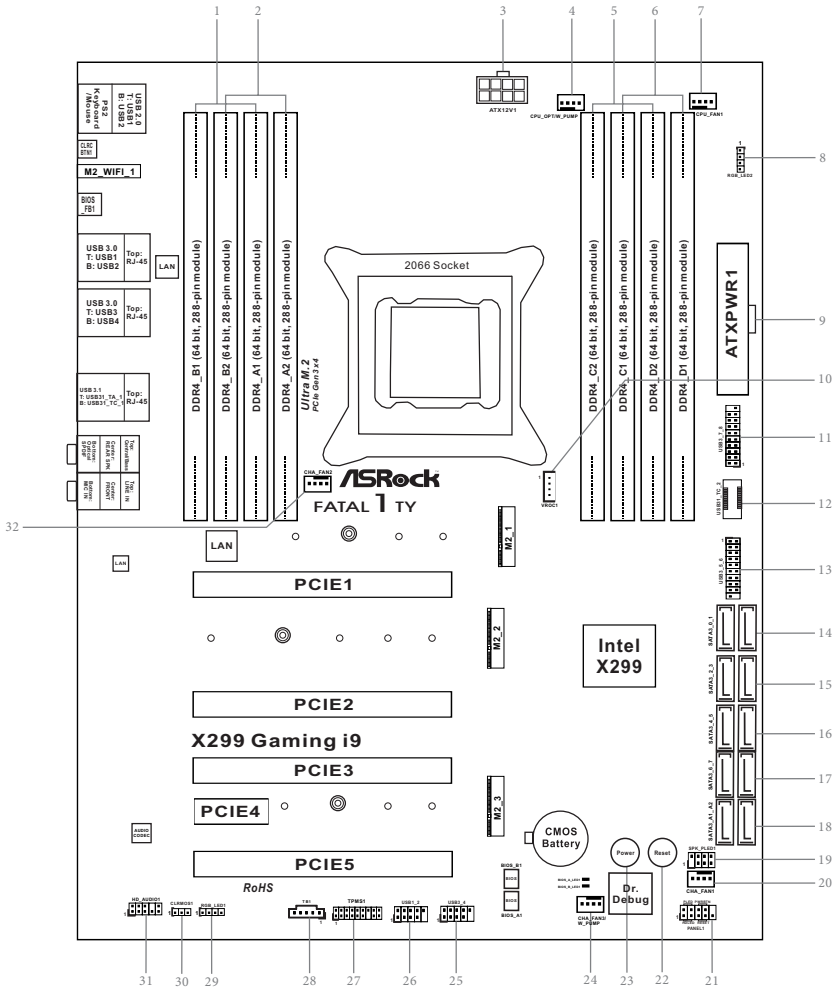

No.	Description
1	2 x 288-pin DDR4 DIMM Slots (DDR4_A1, DDR4_B1)
2	2 x 288-pin DDR4 DIMM Slots (DDR4_A2, DDR4_B2)
3	ATX 12V Power Connector (ATX12V1)
4	CPU Fan / Waterpump Fan Connector (CPU_OPT/W_PUMP)
5	2 x 288-pin DDR4 DIMM Slots (DDR4_C2, DDR4_D2)
6	2 x 288-pin DDR4 DIMM Slots (DDR4_C1, DDR4_D1)
7	CPU Fan Connector (CPU_FAN1)
8	RGB LED Header (RGB_LED2)
9	ATX Power Connector (ATXPWR1)
10	Virtual RAID On CPU Header (VROCI)
11	USB 3.0 Header (USB3_7_8)
12	Front Panel Type C USB 3.1 Header (USB31_TC_2)
13	USB 3.0 Header (USB3_5_6)
14	SATA3 Connectors (SATA3_0_1)
15	SATA3 Connectors (SATA3_2_3)
16	SATA3 Connectors (SATA3_4_5)
17	SATA3 Connectors (SATA3_6_7)
18	SATA3 Connectors (SATA3_A1_A2)
19	Power LED and Speaker Header (SPK_PLED1)
20	Chassis Fan Connector (CHA_FAN1)
21	System Panel Header (PANEL1)
22	Reset Switch (RSTBTN1)
23	Power Switch (PWRBTN1)
24	Chassis Fan / Waterpump Fan Connector (CHA_FAN3/W_PUMP)
25	USB 2.0 Header (USB3_4)
26	USB 2.0 Header (USB1_2)
27	TPM Header (TPMS1)
28	Thunderbolt AIC Header (TB1)
29	RGB LED Header (RGB_LED1)
30	Clear CMOS Jumper (CLRMOS1)
31	Front Panel Audio Header (HD_AUDIO1)
32	Chassis Fan Connector (CHA_FAN2)

1.4 I/O Panel

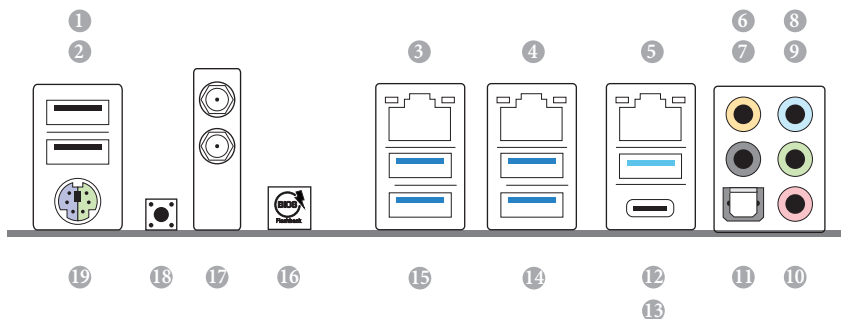

No.	Description	No.	Description
1	FatalIty Mouse Port (USB1)	11	Optical SPDIF Out Port
2	USB 2.0 Port (USB2)	12	USB 3.1 Type-A Port (USB31_TA_1)
3	LAN RJ-45 Port (Intel® I211AT)*	13	USB 3.1 Type-C Port (USB31_TC_1)
4	10 GLAN RJ-45 Port (AQUANTIA® AQC107)**	14	USB 3.0 Ports (USB3_34)
5	LAN RJ-45 Port (Intel® I219V)*	15	USB 3.0 Ports (USB3_12)****
6	Central / Bass (Orange)	16	BIOS Flashback Switch
7	Rear Speaker (Black)	17	Antenna Ports
8	Line In (Light Blue)	18	Clear CMOS Switch
9	Front Speaker (Lime)***	19	PS/2 Mouse/Keyboard Port (PS2_KB1)
10	Microphone (Pink)		

* There are two LEDs on each LAN port. Please refer to the table below for the LAN port LED indications.

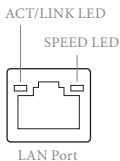

Activity / Link LED		Speed LED	
Status	Description	Status	Description
Off	No Link	Orange	10Mbps connection
Blinking	Data Activity	Orange	100Mbps connection
On	Link	Green	1Gbps connection

** There are two LEDs on each LAN port. Please refer to the table below for the LAN port LED indications.

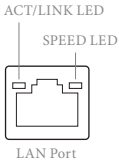

Activity / Link LED		Speed LED	
Status	Description	Status	Description
Off	No Link	Orange	100Mbps/1Gbps/2.5Gbps connection
Blinking	Data Activity	Green	10Gbps connection
On	Link		

*** If you use a 2-channel speaker, please connect the speaker's plug into "Front Speaker Jack". See the table below for connection details in accordance with the type of speaker you use.

Audio Output Channels	Front Speaker (No. 9)	Rear Speaker (No. 7)	Central / Bass (No. 6)	Line In (No. 8)
2	V	--	--	--
4	V	V	--	--
6	V	V	V	--
8	V	V	V	V



To enable Multi-Streaming, you need to connect a front panel audio cable to the front panel audio header. After restarting your computer, you will find the "Mixer" tool on your system. Please select "Mixer Toolbox" , click "Enable playback multi-streaming", and click "ok". Choose "2CH", "4CH", "6CH", or "8CH" and then you are allowed to select "Realtek HDA Primary output" to use the Rear Speaker, Central/Bass, and Front Speaker, or select "Realtek HDA Audio 2nd output" to use the front panel audio.

**** ACPI wake-up function is not supported on USB3_12 ports.

1.5 WiFi-802.11ac Module and ASRock WiFi 2.4/5 GHz Antenna

WiFi-802.11ac + BT Module

This motherboard comes with an exclusive WiFi 802.11 a/b/g/n/ac + BT v4.0 module (pre-installed on the rear I/O panel) that offers support for WiFi 802.11 a/b/g/n/ac connectivity standards and Bluetooth v4.0. WiFi + BT module is an easy-to-use wireless local area network (WLAN) adapter to support WiFi + BT. Bluetooth v4.0 standard features Smart Ready technology that adds a whole new class of functionality into the mobile devices. BT 4.0 also includes Low Energy Technology and ensures extraordinary low power consumption for PCs.

* The transmission speed may vary according to the environment.

WiFi Antennas Installation Guide



Step 1

Prepare the WiFi 2.4/5 GHz Antennas that come with the package.

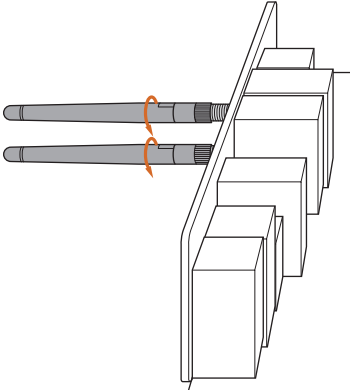

Step 2

Connect the two WiFi 2.4/5 GHz Antennas to the antenna connectors. Turn the antenna clockwise until it is securely connected.

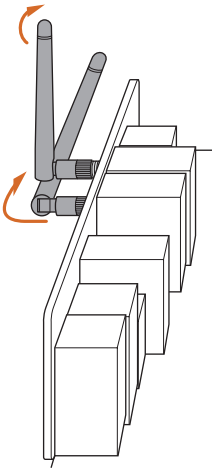

Step 3

Set the WiFi 2.4/5 GHz Antenna as shown in the illustration.

*You may need to adjust the direction of the antenna for a stronger signal.

Chapter 2 Installation

This is an ATX form factor motherboard. Before you install the motherboard, study the configuration of your chassis to ensure that the motherboard fits into it.

Pre-installation Precautions

Take note of the following precautions before you install motherboard components or change any motherboard settings.

- Make sure to unplug the power cord before installing or removing the motherboard components. Failure to do so may cause physical injuries and damages to motherboard components.
- In order to avoid damage from static electricity to the motherboard's components, NEVER place your motherboard directly on a carpet. Also remember to use a grounded wrist strap or touch a safety grounded object before you handle the components.
- Hold components by the edges and do not touch the ICs.
- Whenever you uninstall any components, place them on a grounded anti-static pad or in the bag that comes with the components.
- When placing screws to secure the motherboard to the chassis, please do not over-tighten the screws! Doing so may damage the motherboard.

2.1 Installing the CPU



1. Before you insert the **2066-Pin CPU** into the socket, please check if the **PnP cap** is on the socket, if the CPU surface is unclean, or if there are any **bent pins** in the socket. Do not force to insert the CPU into the socket if above situation is found. Otherwise, the CPU will be seriously damaged.
2. Unplug all power cables before installing the CPU.

CAUTION:

Please note that X299 platform is only compatible with the **LGA 2066 socket**, which is incompatible with the LGA 2011-3 socket (for X99 platform).

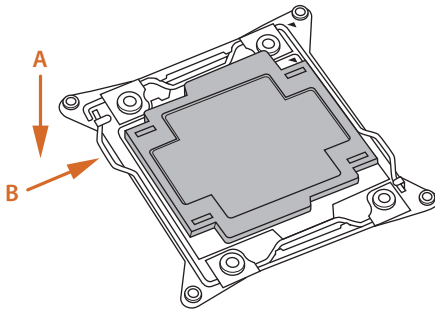
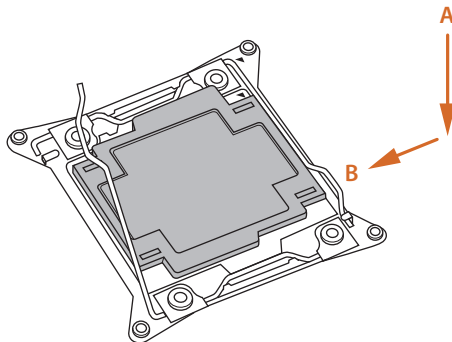
1**2**

3

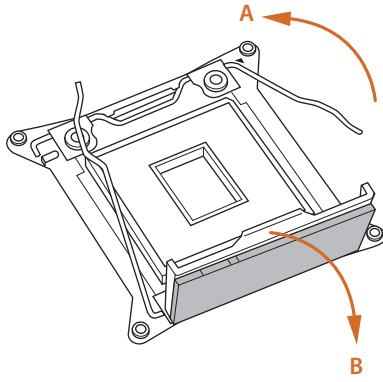

4

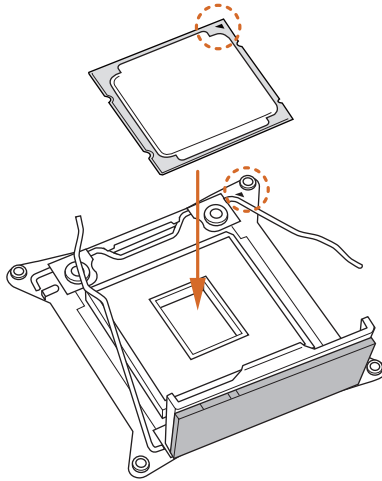

5

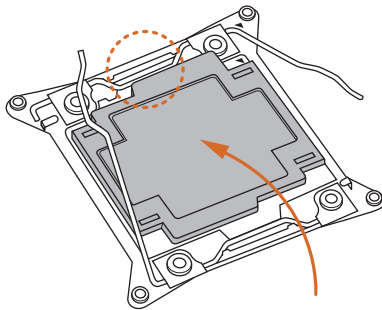

6

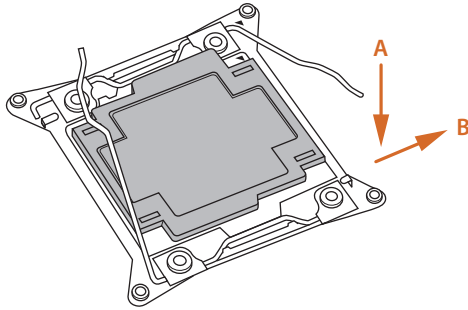

7

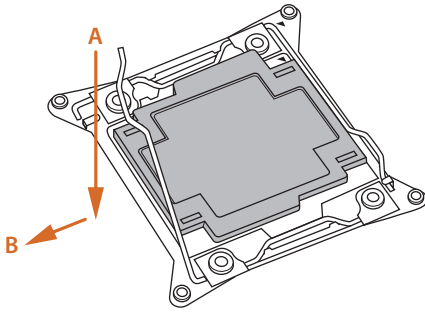

8

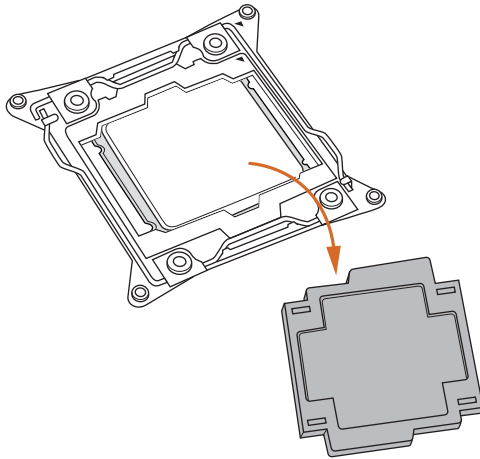

Please save and replace the cover if the processor is removed. The cover must be placed if you wish to return the motherboard for after service.

2.2 Installing the CPU Fan and Heatsink

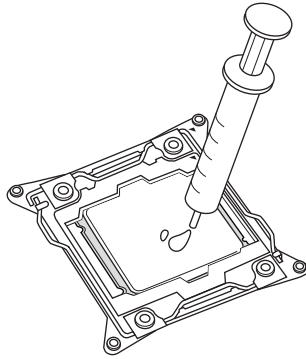

1

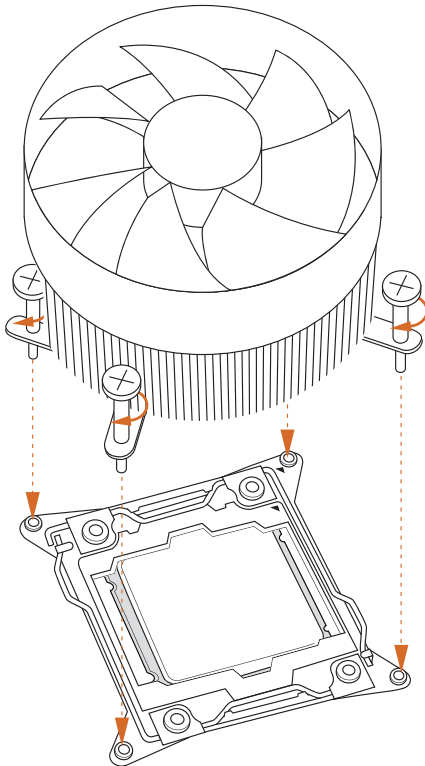

2

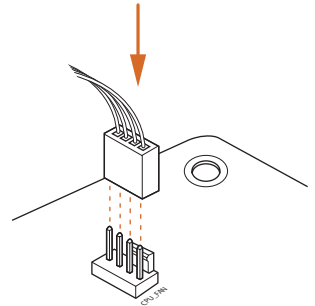

2.3 Installation of Memory Modules (DIMM)

This motherboard provides eight 288-pin DDR4 (Double Data Rate 4) DIMM slots, and supports Quad Channel Memory Technology.



1. For quad channel configuration, you always need to install identical (the same brand, speed, size and chip-type) DDR4 DIMM pairs.
2. It is not allowed to install a DDR, DDR2 or DDR3 memory module into a DDR4 slot; otherwise, this motherboard and DIMM may be damaged.
3. The DIMM only fits in one correct orientation. It will cause permanent damage to the motherboard and the DIMM if you force the DIMM into the slot at incorrect orientation.

Quad Channel Memory Configuration (For CPU with 44 or 28 PCIe lanes)

Priority	1	2
DDR4_B1	Populated	Populated
DDR4_B2		Populated
DDR4_A1	Populated	Populated
DDR4_A2		Populated
DDR4_D1	Populated	Populated
DDR4_D2		Populated
DDR4_C1	Populated	Populated
DDR4_C2		Populated

Dual Channel Memory Configuration (For CPU with 16 PCIe lanes)

Priority	1	2
DDR4_D1	Populated	Populated
DDR4_D2		Populated
DDR4_C1	Populated	Populated
DDR4_C2		Populated

- Due to Intel® CPU spec definition, please install the memory modules on DDR4_A1, DDR4_B1, DDR4_C1 and DDR4_D1 for first priority. If the four DDR4 DIMM slots above are fully installed, and you want to use more than four memory modules, please install the other memory modules from left to right (from DDR4_A2, DDR4_B2, DDR4_D2 to DDR4_C2.)
- If only two memory modules are installed in the DDR4 DIMM slots, then Dual Channel Memory Technology is activated. If three memory modules are installed, then Triple Channel Memory Technology is activated. If more than four memory modules are installed in the DDR4 DIMM slots, then Quad Channel Memory Technology is activated.

- For CPU with 16 PCIe lanes, please install the memory modules on DDR4_C1, C2, D1 and D2 only.

1

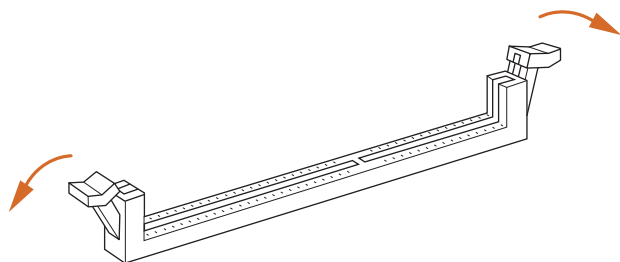

2

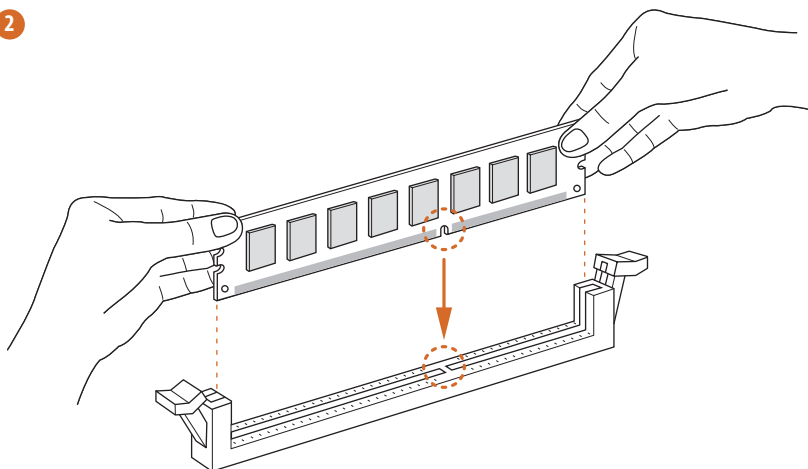

3

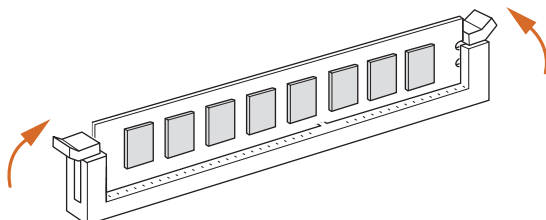

2.4 Expansion Slots (PCI Express Slots)

There are 5 PCI Express slots on the motherboard.



Before installing an expansion card, please make sure that the power supply is switched off or the power cord is unplugged. Please read the documentation of the expansion card and make necessary hardware settings for the card before you start the installation.

PCIe slots:

PCIE1 (PCIe 3.0 x16 slot) is used for PCI Express x16 lane width graphics cards.

PCIE2 (PCIe 3.0 x16 slot) is used for PCI Express x8 lane width graphics cards.

PCIE3 (PCIe 3.0 x16 slot) is used for PCI Express x16 lane width graphics cards.

PCIE4 (PCIe 2.0 x1 slot) is used for PCI Express x1 lane width cards.

PCIE5 (PCIe 3.0 x16 slot) is used for PCI Express x8 lane width graphics cards.

* If you install CPU with 44 lanes, PCIE1/PCIE2/PCIE3/PCIE5 will run at x16/x8/x16/x0 or x8/x8/x16/x8.

* If you install CPU with 28 lanes, PCIE1/PCIE2/PCIE3/PCIE5 will run at x16/x0/x8/x0 or x8/x0/x8/x8.

* If you install CPU with 16 lanes, PCIE1/PCIE2/PCIE3/PCIE5 will run at x16/x0/x0/x0 or x8/x0/x4/x0.

PCIe Slot Configurations (For CPU with 44 PCIe lanes)

	PCIE1	PCIE2	PCIE3	PCIE4	PCIE5	M2_1
Single Graphics Card	x16	N/A	N/A	N/A	N/A	x4
Two Graphics Cards in CrossFireX™ or SLI™ Mode	x16	N/A	x16	N/A	N/A	x4
Three Graphics Cards in 3-Way CrossFireX™ Mode or 3-Way SLI™ Mode	x8	N/A	x16	N/A	x8	x4

PCIe Slot Configurations (For CPU with 28 PCIe lanes)

	PCI E1	PCI E2	PCI E3	PCI E4	PCI E5	M2_1
Single Graphics Card	x16	N/A	N/A	N/A	N/A	x4
Two Graphics Cards in CrossFireX™ or SLI™ Mode	x16	N/A	x8	N/A	N/A	x4
Three Graphics Cards in 3-Way CrossFireX™ Mode or 3-Way SLI™ Mode	x8	N/A	x8	N/A	x8	x4

PCIe Slot Configurations (For CPU with 16 PCIe lanes)

	PCI E1	PCI E2	PCI E3	PCI E4	PCI E5	M2_1
Single Graphics Card	x16	N/A	N/A	N/A	N/A	x0
Two Graphics Cards in CrossFireX™ Mode	x8	N/A	x4	N/A	N/A	x4



For a better thermal environment, please connect a chassis fan to the motherboard's | chassis fan connector (CHA_FAN1, CHA_FAN2 or CHA_FAN3) when using multiple graphics cards.

* If you install CPU with 44 or 28 lanes and encounter CrossFire issues, please do the followings.

1. Enter UEFI by pressing <F2> or during system startup.
2. Select "Boot > CSM" from the menu.
3. Set "Launch Storage OpROM policy" to "UEFI only".
4. Press F10 to Save and Exit.

2.5 Jumpers Setup

The illustration shows how jumpers are setup. When the jumper cap is placed on the pins, the jumper is “Short”. If no jumper cap is placed on the pins, the jumper is “Open”. The illustration shows a 3-pin jumper whose pin1 and pin2 are “Short” when a jumper cap is placed on these 2 pins.

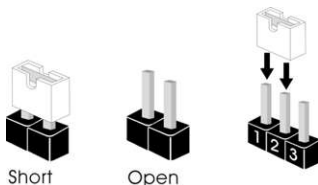

Clear CMOS Jumper
(CLRMOSt)
(see p.8, No. 30)

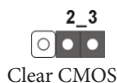

CLRMOSt allows you to clear the data in CMOS. To clear and reset the system parameters to default setup, please turn off the computer and unplug the power cord from the power supply. After waiting for 15 seconds, use a jumper cap to short pin2 and pin3 on CLRMOSt for 5 seconds. However, please do not clear the CMOS right after you update the BIOS. If you need to clear the CMOS when you just finish updating the BIOS, you must boot up the system first, and then shut it down before you do the clear-CMOS action. Please be noted that the password, date, time, and user default profile will be cleared only if the CMOS battery is removed.

2.6 Onboard Headers and Connectors



Onboard headers and connectors are NOT jumpers. Do NOT place jumper caps over these headers and connectors. Placing jumper caps over the headers and connectors will cause permanent damage to the motherboard.

System Panel Header
(9-pin PANEL1)
(see p.8, No. 21)

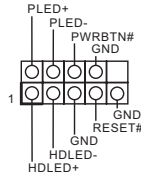

Connect the power switch, reset switch and system status indicator on the chassis to this header according to the pin assignments below. Note the positive and negative pins before connecting the cables.



PWRBTN (Power Switch):

Connect to the power switch on the chassis front panel. You may configure the way to turn off your system using the power switch.

RESET (Reset Switch):

Connect to the reset switch on the chassis front panel. Press the reset switch to restart the computer if the computer freezes and fails to perform a normal restart.

PLED (System Power LED):

Connect to the power status indicator on the chassis front panel. The LED is on when the system is operating. The LED keeps blinking when the system is in S1/S3 sleep state. The LED is off when the system is in S4 sleep state or powered off (S5).

HDLED (Hard Drive Activity LED):

Connect to the hard drive activity LED on the chassis front panel. The LED is on when the hard drive is reading or writing data.

The front panel design may differ by chassis. A front panel module mainly consists of power switch, reset switch, power LED, hard drive activity LED, speaker and etc. When connecting your chassis front panel module to this header, make sure the wire assignments and the pin assignments are matched correctly.

Power LED and Speaker

Header

(7-pin SPK_PLED1)

(see p.8, No. 19)

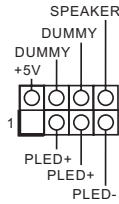

Please connect the chassis power LED and the chassis speaker to this header.

Serial ATA3 Connectors

(SATA3_0_1:

see p.8, No. 14)

(SATA3_2_3:

see p.8, No. 15)

(SATA3_4_5:

see p.8, No. 16)

(SATA3_6_7:

see p.8, No. 17)

(SATA3_A1_A2:

see p.8, No. 18)



These ten SATA3 connectors support SATA data cables for internal storage devices with up to 6.0 Gb/s data transfer rate.

* To minimize the boot time, use Intel® X299 SATA ports (SATA3_0~7) for your bootable devices.

* If M2_1 is occupied by a SATA-type M.2 device, SATA3_1 will be disabled.

* If M2_2 is occupied by a SATA-type M.2 device, SATA3_0 will be disabled.

* If M2_3 is occupied by a SATA-type M.2 device, SATA3_7 will be disabled.

USB 2.0 Headers

(9-pin USB1_2)

(see p.8, No. 26)

(9-pin USB3_4)

(see p.8, No. 25)

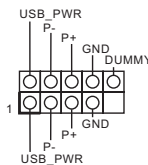

There are two headers on this motherboard. Each USB 2.0 header can support two ports.

USB 3.0 Headers

(19-pin USB3_5_6)

(see p.8, No. 13)

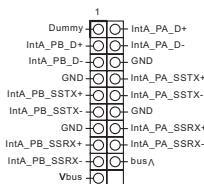

There are two headers on this motherboard. Each USB 3.0 header can support two ports.

(19-pin USB3_7_8)

(see p.8, No. 11)

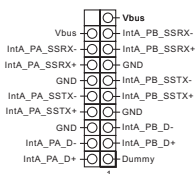

Front Panel Type C USB

3.1 Header

(26-pin USB31_TC_2)

(see p.8, No. 12)



There is one Front Panel

Type C USB 3.1 Header

on this motherboard.

This header is used for

connecting a USB 3.1

module for additional

USB 3.1 ports.

Front Panel Audio Header

(9-pin HD_AUDIO1)

(see p.8, No. 31)

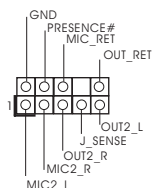

This header is for

connecting audio devices

to the front audio panel.



1. High Definition Audio supports Jack Sensing, but the panel wire on the chassis must support HDA to function correctly. Please follow the instructions in our manual and chassis manual to install your system.
2. If you use an AC'97 audio panel, please install it to the front panel audio header by the steps below:
 - A. Connect Mic_IN (MIC) to MIC2_L.
 - B. Connect Audio_R (RIN) to OUT2_R and Audio_L (LIN) to OUT2_L.
 - C. Connect Ground (GND) to Ground (GND).
 - D. MIC_RET and OUT_RET are for the HD audio panel only. You don't need to connect them for the AC'97 audio panel.
 - E. To activate the front mic, go to the "FrontMic" Tab in the Realtek Control panel and adjust "Recording Volume".

Chassis Fan Connectors

(4-pin CHA_FAN1)

(see p.8, No. 20)

(4-pin CHA_FAN2)

(see p.8, No. 32)

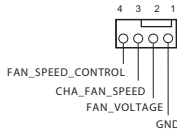

Please connect fan cables to the fan connectors and match the black wire to the ground pin.

Chassis Optional/Water Pump Fan Connector

(4-pin CHA_FAN3/W_PUMP)

(see p.8, No. 24)

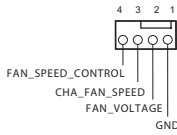

This motherboard provides two 4-Pin water cooling chassis fan connectors. If you plan to connect a 3-Pin chassis water cooler fan, please connect it to Pin 1-3.

CPU Fan Connector

(4-pin CPU_FAN1)

(see p.8, No. 7)

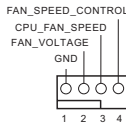

This motherboard provides a 4-Pin CPU fan (Quiet Fan) connector. If you plan to connect a 3-Pin CPU fan, please connect it to Pin 1-3.

CPU Optional/Water Pump Fan Connector

(4-pin CPU_OPT/W_PUMP)

(see p.8, No. 4)

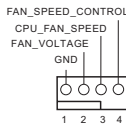

This motherboard provides a 4-Pin water cooling CPU fan connector. If you plan to connect a 3-Pin CPU water cooler fan, please connect it to Pin 1-3.

ATX Power Connector

(24-pin ATXPWR1)

(see p.8, No. 9)

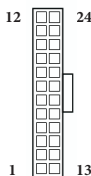

This motherboard provides a 24-pin ATX power connector. To use a 20-pin ATX power supply, please plug it along Pin 1 and Pin 13.

ATX 12V Power Connector
(8-pin ATX12V1)
(see p.8, No. 3)

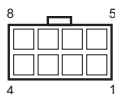

This motherboard provides an 8-pin ATX 12V power connector. To use a 4-pin ATX power supply, please plug it along Pin 1 and Pin 5.

TPM Header
(17-pin TPMS1)
(see p.8, No. 27)

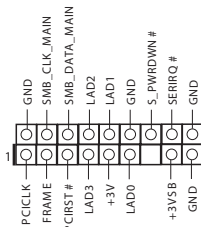

This connector supports Trusted Platform Module (TPM) system, which can securely store keys, digital certificates, passwords, and data. A TPM system also helps enhance network security, protects digital identities, and ensures platform integrity.

Thunderbolt AIC Connector
(5-pin TB1)
(see p.8, No. 28)

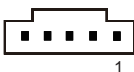

Please connect a Thunderbolt™ add-in card (AIC) to this connector via the GPIO cable.
*The Thunderbolt™ AIC card can be installed in the enabled PCIe slot (depending on CPU type).
If you install CPU with 44 lanes, install the card to PCIE2.
If you install CPU with 28 lanes, install the card to PCIE3.
If you install CPU with 16 lanes, install the card to PCIE3.

RGB LED Headers
(4-pin RGB_LED1)
(see p.8, No. 29)



(4-pin RGB_LED2)
(see p.8, No. 8)



These two RGB headers are used to connect RGB LED extension cable which allows users to choose from various LED lighting effects.

Caution: Never install the RGB LED cable in the wrong orientation; otherwise, the cable may be damaged.

*Please refer to page 57 for further instructions on these two headers.

Virtual RAID On CPU
Header
(4-pin VROC1)
(see p.8, No. 10)

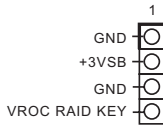

This connector supports Intel®
Virtual RAID on CPU and
NVME/AHCI RAID on CPU
PCIE.

With the introduction of the Intel VROC product, there are three modes of operation:

SKU	HW key required	Key features
Pass-thru	Not needed	<ul style="list-style-type: none"> Pass-thru only (no RAID) LED Management Hot Plug Support RAID 0 support for Intel Fultondale NVMe SSDs
Standard	VROCSTANMOD	<ul style="list-style-type: none"> Pass-thru SKU features RAID 0, 1, 10
Premium	VROCPREMMOD	<ul style="list-style-type: none"> Standard SKU features RAID 5
ISS	VROCISSDMOD	<ul style="list-style-type: none"> RAID 5 Write Hole Closure

*Only Intel SSDs are supported.

*For further details on VROC, please refer to the official information released by Intel.

2.7 Smart Switches

The motherboard has four smart switches: Power Switch, Reset Switch, Clear CMOS Switch and one BIOS Flashback Switch, allowing users to quickly turn on/off the system, reset the system, clear the CMOS values or flash the BIOS.

Power Switch
(PWRBTN)
(see p.8, No. 23)



Power Switch allows users to quickly turn on/off the system.

Reset Switch
(RSTBTN)
(see p.8, No. 22)



Reset Switch allows users to quickly reset the system.

Clear CMOS Switch
(CLRCBTN)
(see p.10, No. 18)



Clear CMOS Switch allows users to quickly clear the CMOS values.



This function is workable only when you power off your computer and unplug the power supply.

BIOS Flashback Switch
(BIOS_FB1)
(see p.10, No. 16)



BIOS Flashback Switch allows users to flash the BIOS.

To use USB BIOS Flashback function, press the BIOS Flashback Switch for three seconds. Please follow the steps below.

1. Download the latest BIOS file from ASRock's website : <http://www.asrock.com>.
2. Copy the BIOS file to your USB flash drive. Please make sure the file system of your USB flash drive must be FAT32.
3. Extract BIOS file from the zip file.
4. Rename the file to “**creative.rom**” and save it to the root directory of X: USB flash drive.
5. Make sure that the CPU is not installed; then install PSU and turn it on.
6. Press the BIOS Flashback Switch for about three seconds. Then the LED starts to blink.
7. Wait until the LED stops blinking, indicating that BIOS flashing has been completed.

*If the LED light turns solid green, this means that the BIOS Flashback is not operating properly.

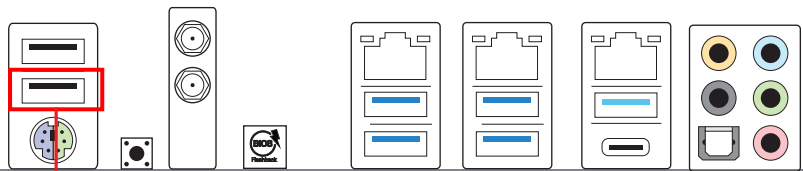

USB BIOS Flashback port

2.8 Dr. Debug

Dr. Debug is used to provide code information, which makes troubleshooting even easier. Please see the diagrams below for reading the Dr. Debug codes.

Code	Description
00	Please check if the CPU is installed correctly and then clear CMOS.
0d	Problem related to memory, VGA card or other devices. Please clear CMOS, re-install the memory and VGA card, and remove other USB, PCI devices.
01 - 54 (except 0d), 5A- 60	Problem related to memory. Please re-install the CPU and memory then clear CMOS. If the problem still exists, please install only one memory module or try using other memory modules.
55	The Memory could not be detected. Please re-install the memory and CPU. If the problem still exists, please install only one memory module or try using other memory modules.
61 - 91	Chipset initialization error. Please press reset or clear CMOS.
92 - 99	Problem related to PCI-E devices. Please re-install PCI-E devices or try installing them in other slots. If the problem still exists, please remove all PCI-E devices or try using another VGA card.
A0 - A7	Problem related to IDE or SATA devices. Please re-install IDE and SATA devices. If the problem still exists, please clear CMOS and try removing all SATA devices.
b0	Problem related to memory. Please re-install the CPU and memory. If the problem still exists, please install only one memory module or try using other memory modules.

b4 Problem related to USB devices. Please try removing all USB devices.

b7 Problem related to memory. Please re-install the CPU and memory then clear CMOS. If the problem still exists, please install only one memory module or try using other memory modules.

d6 The VGA could not be recognized. Please clear CMOS and try re-installing the VGA card. If the problem still exists, please try installing the VGA card in other slots or use other VGA cards.

d7 The Keyboard and mouse could not be recognized. Please try re-installing the keyboard and mouse.

d8 Invalid Password.

FF Please check if the CPU is installed correctly and then clear CMOS.

2.9 SLI™, 3-Way SLI™ and Quad SLI™ Operation Guide

This motherboard supports NVIDIA® SLI™, 3-Way SLI™ and Quad SLI™ (Scalable Link Interface) technology that allows you to install up to three identical PCI Express x16 graphics cards. Currently, NVIDIA® SLI™ and Quad SLI™ technology supports Windows® 10 64-bit

*This feature is only supported with CPU with 44 lanes or 28 lanes.



Requirements

1. You should only use identical SLI™-ready graphics cards that are NVIDIA® certified.
2. Make sure that your graphics card driver supports NVIDIA® SLI™ technology. Download the drivers from the NVIDIA® website: www.nvidia.com
3. Make sure that your power supply unit (PSU) can provide at least the minimum power your system requires. It is recommended to use a NVIDIA® certified PSU. Please refer to the NVIDIA® website for details.

2.9.1 Installing Two SLI™-Ready Graphics Cards

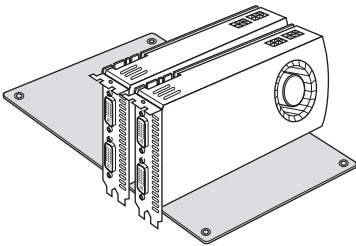

Step 1

Insert one graphics card into PCIE1 slot and the other graphics card to PCIE3 slot. Make sure that the cards are properly seated on the slots.

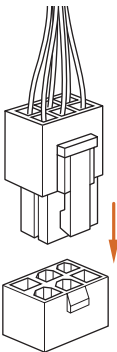

Step 2

If required, connect the auxiliary power source to the PCI Express graphics cards.

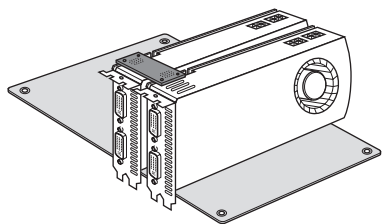

Step 3

Align and insert the ASRock SLI_HB_Bridge_2S Card to the goldfingers on each graphics card. Make sure the ASRock SLI_HB_Bridge_2S Card is firmly in place.



ASRock SLI_HB_Bridge_2S Card

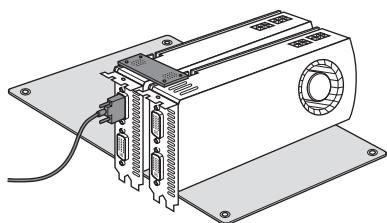

Step 4

Connect a VGA cable or a DVI cable to the monitor connector or the DVI connector of the graphics card that is inserted to PCIE1 slot.

2.9.2 Installing Three SLI™-Ready Graphics Cards

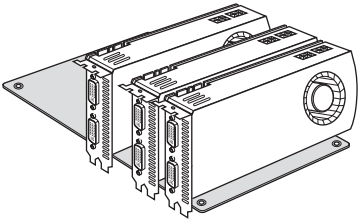

Step 1

Insert one graphics card into PCIe1 slot, another graphics card to PCIe3 slot, and the other graphics card to PCIe5 slot. Make sure that the cards are properly seated on the slots.

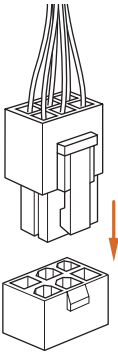

Step 2

Connect the auxiliary power source to the PCI Express graphics card. Please make sure that both power connectors on the PCI Express graphics card are connected. Repeat this step on the three graphics cards.

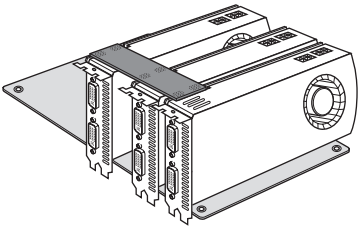

Step 3

Align and insert the ASRock 3-Way SLI-2SIS Bridge Card to the goldfingers on each graphics card. Make sure the ASRock 3-Way SLI-2SIS Bridge Card is firmly in place.

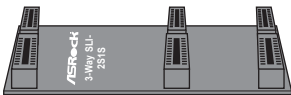

3-Way SLI-2SIS Bridge Card

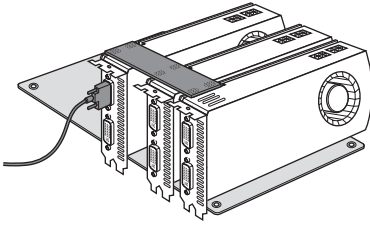

Step 4

Connect a VGA cable or a DVI cable to the monitor connector or the DVI connector of the graphics card that is inserted to PCIE1 slot.

2.9.3 Driver Installation and Setup

Install the graphics card drivers to your system. After that, you can enable the Multi-Graphics Processing Unit (GPU) in the NVIDIA® nView system tray utility. Please follow the below procedures to enable the multi-GPU.



Step 1

Double-click the **NVIDIA Control Panel** icon in the Windows' system tray.

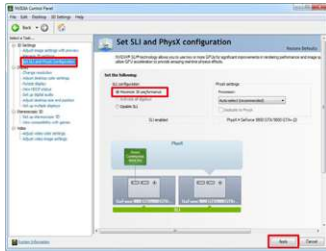

Step 2

In the left pane, click **Set SLI and PhysX configuration**. Then select **Maximize 3D performance** and click **Apply**.

Step 3

Reboot your system.

2.10 CrossFireX™, 3-Way CrossFireX™ and Quad CrossFireX™ Operation Guide

This motherboard supports CrossFireX™, 3-way CrossFireX™ and Quad CrossFireX™ that allows you to install up to three identical PCI Express x16 graphics cards. Currently CrossFireX™, 3-way CrossFireX™ and Quad CrossFireX™ are supported with Windows® 10 64-bit OS.

* 3-Way CrossFireX™ is only supported with CPU with 44 lanes or 28 lanes.



1. You should only use identical CrossFireX™-ready graphics cards that are AMD certified.
2. Make sure that your graphics card driver supports AMD CrossFireX™ technology. Download the drivers from the AMD's website: www.amd.com
3. Make sure that your power supply unit (PSU) can provide at least the minimum power your system requires. It is recommended to use a AMD certified PSU. Please refer to the AMD's website for details.
4. If you pair a 12-pipe CrossFireX™ Edition card with a 16-pipe card, both cards will operate as 12-pipe cards while in CrossFireX™ mode.
5. Different CrossFireX™ cards may require different methods to enable CrossFireX™. Please refer to AMD graphics card manuals for detailed installation guide.

2.10.1 Installing Two CrossFireX™-Ready Graphics Cards

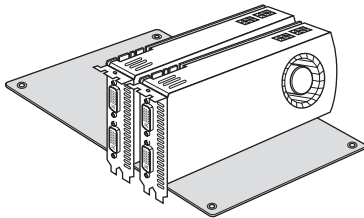

Step 1

Insert one graphics card into PCIe1 slot and the other graphics card to PCIe3 slot. Make sure that the cards are properly seated on the slots.



CrossFire Bridge

Step 2

Connect two graphics cards by installing a CrossFire Bridge on the CrossFire Bridge Interconnects on the top of the graphics cards. (The CrossFire Bridge is provided with the graphics card you purchase, not bundled with this motherboard. Please refer to your graphics card vendor for details.)

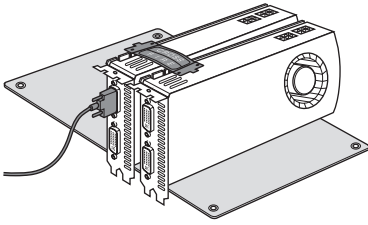

Step 3

Connect a VGA cable or a DVI cable to the monitor connector or the DVI connector of the graphics card that is inserted to PCIE1 slot.

2.10.2 Installing Three CrossFireX™-Ready Graphics Cards

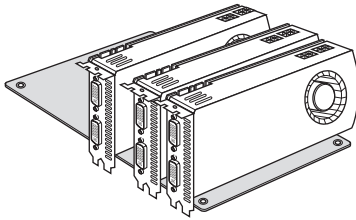

Step 1

Insert one graphics card into PCI Express 1x slot, another graphics card to PCI Express 3x slot, and the other graphics card to PCI Express 5x slot. Make sure that the cards are properly seated on the slots.



CrossFire Bridge

Step 2

Use one CrossFire Bridge to connect the graphics cards on PCI Express 1x and PCI Express 3x slots, and use the other CrossFire Bridge to connect the graphics cards on PCI Express 3x and PCI Express 5x slots. (The CrossFire Bridge is provided with the graphics card you purchase, not bundled with this motherboard. Please refer to your graphics card vendor for details.)

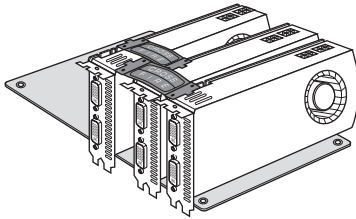

Step 3

Connect a VGA cable or a DVI cable to the monitor connector or the DVI connector of the graphics card that is inserted to PCI Express 1x slot.

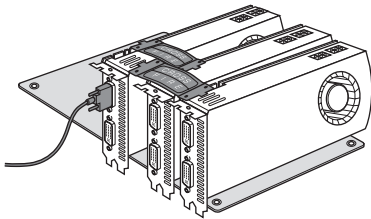

2.10.3 Driver Installation and Setup

Step 1

Power on your computer and boot into OS.

Step 2

Remove the AMD drivers if you have any VGA drivers installed in your system.



The Catalyst Uninstaller is an optional download. We recommend using this utility to uninstall any previously installed Catalyst drivers prior to installation. Please check AMD's website for AMD driver updates.

Step 3

Install the required drivers and CATALYST Control Center then restart your computer. Please check AMD's website for details.



AMD Catalyst Control Center

Step 4

Double-click the **AMD Catalyst Control Center** icon in the Windows system tray.



Step 5

In the left pane, click **Performance** and then **AMD CrossFireX™**. Then select **Enable AMD CrossFireX** and click **Apply**. Select the GPU number according to your graphics card and click **Apply**.

2.11 M.2_SSD (NGFF) Module Installation Guide

The M.2, also known as the Next Generation Form Factor (NGFF), is a small size and versatile card edge connector that aims to replace mPCIe and mSATA. The Ultra M.2 Socket can accommodate either a M.2 SATA3 6.0 Gb/s module or a M.2 PCI Express module up to Gen3 x4 (32 Gb/s).

- * If M2_1 is occupied by a SATA-type M.2 device, SATA3_1 will be disabled.
- * If M2_2 is occupied by a SATA-type M.2 device, SATA3_0 will be disabled.
- * If M2_3 is occupied by a SATA-type M.2 device, SATA3_7 will be disabled.

Installing the M.2_SSD (NGFF) Module

The following is an example of installing M.2_SSD (NGFF) module into the M2_2.

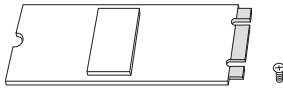

Step 1

Prepare a M.2_SSD (NGFF) module and the screw.

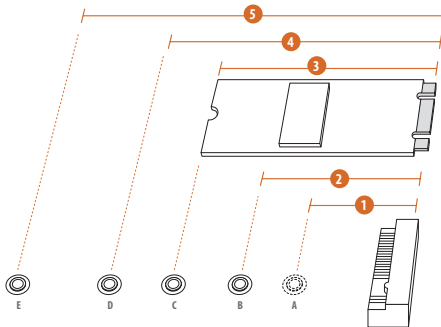

Step 2

Depending on the PCB type and length of your M.2_SSD (NGFF) module, find the corresponding nut location to be used.

No.	1	2	3	4	5
Nut Location	A	B	C	D	E
PCB Length	3cm	4.2cm	6cm	8cm	11cm
Module Type	Type2230	Type 2242	Type2260	Type 2280	Type 22110

Step 3



Move the standoff based on the module type and length. The standoff is placed at the nut location D by default. Skip Step 3 and 4 and go straight to Step 5 if you are going to use the default nut. Otherwise, release the standoff by hand.

Step 4



Peel off the yellow protective film on the nut to be used. Hand tighten the standoff into the desired nut location on the motherboard.

Step 5

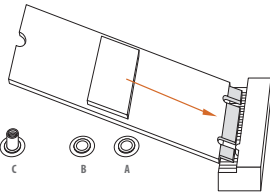

Align and gently insert the M.2 (NGFF) SSD module into the M.2 slot. Please be aware that the M.2 (NGFF) SSD module only fits in one orientation.

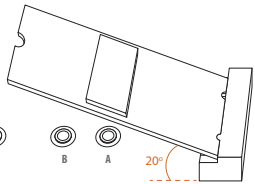

Step 6

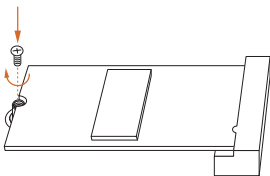

Tighten the screw with a screwdriver to secure the module into place. Please do not overtighten the screw as this might damage the module.

M.2_SSD (NGFF) Module Support List

Vendor	Interface	P/N
ADATA	SATA3	AXNS330E-32GM-B
ADATA	SATA3	AXNS381E-128GM-B
ADATA	SATA3	AXNS381E-256GM-B
ADATA	SATA3	ASU800NS38-256GT-C
ADATA	SATA3	ASU800NS38-512GT-C
ADATA	PCIe3 x4	ASX8000NP-256GM-C
ADATA	PCIe3 x4	ASX8000NP-512GM-C
Crucial	SATA3	CT120M500SSD4
Crucial	SATA3	CT240M500SSD4
Intel	SATA3	Intel SSDSCKGW080A401/80G
Intel	PCIe3 x4	SSDPEKKF256G7
Intel	PCIe3 x4	SSDPEKKF512G7
Kingston	SATA3	SM2280S3
Kingston	PCIe2 x4	SH2280S3/480G
OCZ	PCIe3 x4	RVD400 -M2280-512G (NVME)
Plextor	PCIe3 x4	PX-128M8PeG
Plextor	PCIe3 x4	PX-1TM8PeG
Plextor	PCIe3 x4	PX-256M8PeG
Plextor	PCIe3 x4	PX-512M8PeG
Plextor	PCIe	PX-G256M6e
Plextor	PCIe	PX-G512M6e
Samsung	PCIe3 x4	SM961 MZVPW128HEGM (NVM)
Samsung	PCIe3 x4	PM961 MZVLW128HEGR (NVME)
Samsung	PCIe3 x4	960 EVO (MZ-V6E250BW) (NVME)
Samsung	PCIe3 x4	960 EVO (MZ-V6E250) (NVME)
Samsung	PCIe3 x4	SM951 (MZHPV256HDGL)
Samsung	PCIe3 x4	SM951 (NVME)
Samsung	PCIe3 x4	SM951 (MZHPV512HDGL)
Samsung	PCIe3 x4	SM951 (NVME)
Samsung	PCIe x4	XP941-512G (MZHPU512HCGL)
SanDisk	PCIe	SD6PP4M-128G
SanDisk	PCIe	SD6PP4M-256G
Team	SATA3	TM4PS4128GMC105
Team	SATA3	TM4PS4256GMC105
Team	SATA3	TM8PS4128GMC105
Team	SATA3	TM8PS4256GMC105
Transcend	SATA3	TS256GMTS400
Transcend	SATA3	TS512GMTS600
Transcend	SATA3	TS512GMTS800
V-Color	SATA3	VLM100-120G-2280B-RD
V-Color	SATA3	VLM100-240G-2280B-RD
V-Color	SATA3	VSM100-240G-2280

WD	SATA3	WDS100T1B0B-00AS40
WD	SATA3	WDS240G1G0B-00RC30
WD	PCIe3 x4	WDS256G1X0C-00ENX0 (NVME)
WD	PCIe3 x4	WDS512G1X0C-00ENX0 (NVME)

For the latest updates of M.2_SSD (NFGG) module support list, please visit our website for details: <http://www.asrock.com>

Chapter 3 Software and Utilities Operation

3.1 Installing Drivers

The Support CD that comes with the motherboard contains necessary drivers and useful utilities that enhance the motherboard's features.

Running The Support CD

To begin using the support CD, insert the CD into your CD-ROM drive. The CD automatically displays the Main Menu if "AUTORUN" is enabled in your computer. If the Main Menu does not appear automatically, locate and double click on the file "ASRSETUP.EXE" in the Support CD to display the menu.

Drivers Menu

The drivers compatible to your system will be auto-detected and listed on the support CD driver page. Please click **Install All** or follow the order from top to bottom to install those required drivers. Therefore, the drivers you install can work properly.

Utilities Menu

The Utilities Menu shows the application software that the motherboard supports. Click on a specific item then follow the installation wizard to install it.

3.2 F-Stream

F-Stream is ASRock's multi purpose software suite with a new interface, more new features and improved utilities.

3.2.1 Installing F-Stream

F-Stream can be downloaded from ASRock Live Update & APP Shop. After the installation, you will find the icon "F-Stream" on your desktop. Double-click the "F-Stream"  icon, F-Stream main menu will pop up.

3.2.2 Using F-Stream

There are six sections in F-Stream main menu: Operation Mode, OC Tweaker, System Info, FAN-Tastic Tuning and Settings.

Operation Mode

Choose an operation mode for your computer.

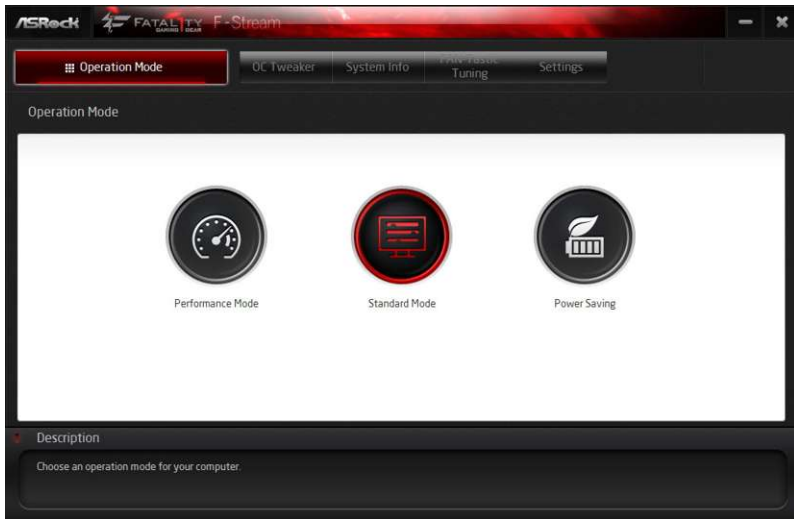

OC Tweaker

Configurations for overclocking the system.



System Info

View information about the system.

*The System Browser tab may not appear for certain models.

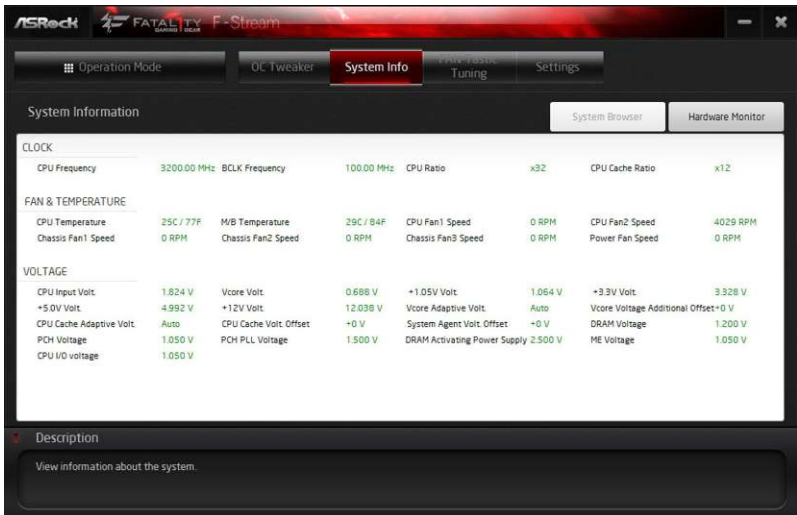

FAN-Tastic Tuning

Configure up to five different fan speeds using the graph. The fans will automatically shift to the next speed level when the assigned temperature is met.

The screenshot shows the 'FAN-Tastic Tuning' window in ASRock F-Stream. The interface includes a navigation bar with 'Operation Mode', 'OC Tweaker', 'System Info', 'FAN-Tastic Tuning', and 'Settings'. The 'FAN-Tastic Tuning' section has a 'Back' button and a 'FAN-Tastic Tuning' title. It contains a graph with 'CPU FAN1 & CPU FAN2' selected, 'Cpu Temp' radio button active, and a 'Start FAN Test' button. The graph plots Fan Speed (%) on the y-axis (0-100) against Temperature (°C) on the x-axis (0-100). A red line shows a step-like increase in fan speed as temperature rises. To the right is a table of Fan Power and Fan Speed settings.

Fan Power	Fan Speed
100%	N/A RPM
90%	N/A RPM
80%	N/A RPM
70%	N/A RPM
60%	N/A RPM
50%	N/A RPM
40%	N/A RPM
30%	N/A RPM
20%	N/A RPM
10%	N/A RPM

Below the graph is a 'Description' section with the text: 'Configure different fan speeds for respective temperatures using the graph. The fans will automatically shift to the next speed level when the assigned temperature is met.' There are 'Apply' and 'Cancel' buttons at the bottom right.

Settings

Configure ASRock F-Stream. Click to select "Auto run at Windows Startup" if you want F-Stream to be launched when you start up the Windows operating system.

The screenshot shows the 'Settings' window in ASRock F-Stream. The 'Settings' tab is active. It features a checkbox for 'Auto run at Windows Startup' which is currently unchecked. Below this is a 'Description' section with the text: 'Configure ASRock F-Stream'. The version number 'Version 3.0.0' is visible in the bottom right corner.

3.3 ASRock Live Update & APP Shop

The ASRock Live Update & APP Shop is an online store for purchasing and downloading software applications for your ASRock computer. You can quickly and easily install various apps and support utilities. With ASRock APP Shop, you can optimize your system and keep your motherboard up to date simply with a few clicks.

Double-click  on your desktop to access ASRock Live Update & APP Shop utility.

**You need to be connected to the Internet to download apps from the ASRock Live Update & APP Shop.*

3.3.1 UI Overview

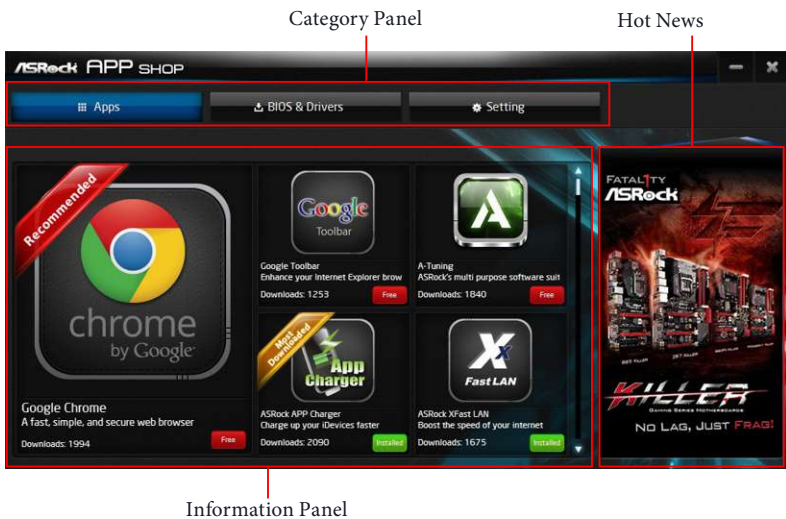

Category Panel: The category panel contains several category tabs or buttons that when selected the information panel below displays the relative information.

Information Panel: The information panel in the center displays data about the currently selected category and allows users to perform job-related tasks.

Hot News: The hot news section displays the various latest news. Click on the image to visit the website of the selected news and know more.

3.3.2 Apps

When the "Apps" tab is selected, you will see all the available apps on screen for you to download.

Installing an App

Step 1

Find the app you want to install.



The most recommended app appears on the left side of the screen. The other various apps are shown on the right. Please scroll up and down to see more apps listed.

You can check the price of the app and whether you have already installed it or not.

Free - The red icon displays the price or "Free" if the app is free of charge.

Installed - The green "Installed" icon means the app is installed on your computer.

Step 2

Click on the app icon to see more details about the selected app.

Step 3

If you want to install the app, click on the red icon **Free** to start downloading.



Step 4

When installation completes, you can find the green "Installed" icon appears on the upper right corner.



To uninstall it, simply click on the trash can icon .

*The trash icon may not appear for certain apps.

Upgrading an App

You can only upgrade the apps you have already installed. When there is an available new version for your app, you will find the mark of "New Version"  appears below the installed app icon.



Step 1

Click on the app icon to see more details.

Step 2

Click on the yellow icon  to start upgrading.

3.3.3 BIOS & Drivers

Installing BIOS or Drivers

When the "BIOS & Drivers" tab is selected, you will see a list of recommended or critical updates for the BIOS or drivers. Please update them all soon.

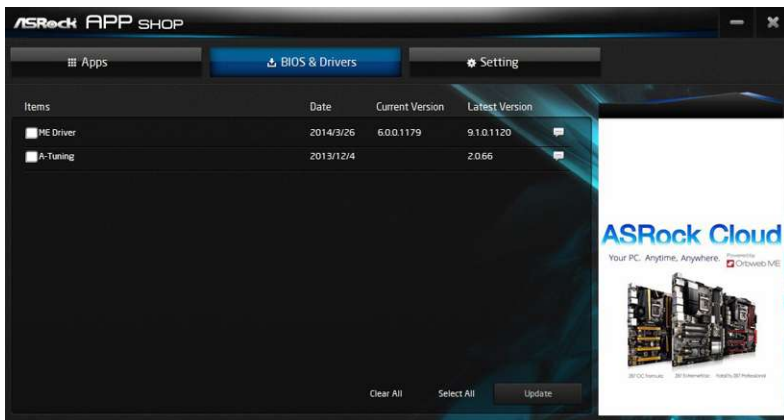

Step 1

Please check the item information before update. Click on  to see more details.

Step 2

Click to select one or more items you want to update.

Step 3

Click Update to start the update process.

3.3.4 Setting

In the "Setting" page, you can change the language, select the server location, and determine if you want to automatically run the ASRock Live Update & APP Shop on Windows startup.

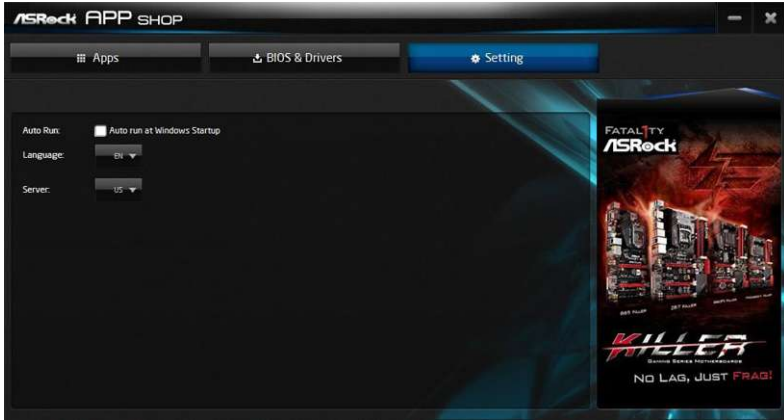

3.4 Creative SoundBlaster Cinema3

The SoundBlaster™ Cinema3, powered by the SBX Pro Studio technologies, is designed to bring the same great audio experience found in live performances, films, and recording studios to the PC. With this utility, you can easily enhance your audio environment in five modes, including Headphones, Speakers, Music, Movie, Game, Voice and Custom.

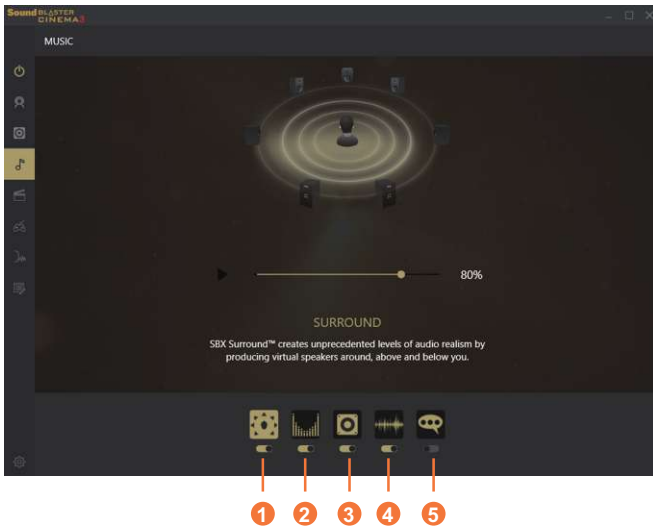

There are five functions in SoundBlaster™ Cinema3:

No.	Function	Description
1	Surround	Creating unprecedented levels of audio realism by producing virtual speakers around, above and below you.
2	Crystalizer	Making music sound as good as the artist originally intended by ensuring that every audio detail is heard.
3	Bass	Enhancing bass sound experience by expanding the low frequency tones.
4	Smart Volume	Minimizing abrupt volume changes by automatically adjusting the loudness of your audio playback.
5	Dialog Plus	Enhancing voices in music and movies for drastically clearer vocal range.

3.5 ASRock RGB LED

ASRock RGB LED is a lighting control utility specifically designed for unique individuals with sophisticated tastes to build their own stylish colorful lighting system. Simply by connecting the LED strip, you can customize various lighting schemes and patterns, including Static, Breathing, Strobe, Cycling, Music, Wave and more.

Connecting the LED Strip

Connect your RGB LED strips to the **RGB LED Headers (RGB_LED1, RGB_LED2)** on the motherboard.

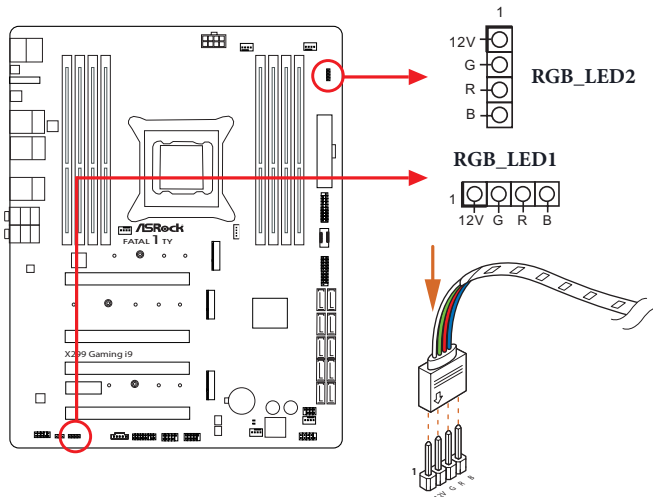

1. Never install the RGB LED cable in the wrong orientation; otherwise, the cable may be damaged.
2. Before installing or removing your RGB LED cable, please power off your system and unplug the power cord from the power supply. Failure to do so may cause damages to motherboard components.



1. Please note that the RGB LED strips do not come with the package.
2. The RGB LED header supports standard 5050 RGB LED strip (12V/G/R/B), with a maximum power rating of 3A (12V) and length within 2 meters.

ASRock RGB LED Utility

Now you can adjust the RGB LED color through the ASRock RGB LED utility. Download this utility from the ASRock Live Update & APP Shop and start coloring your PC style your way!

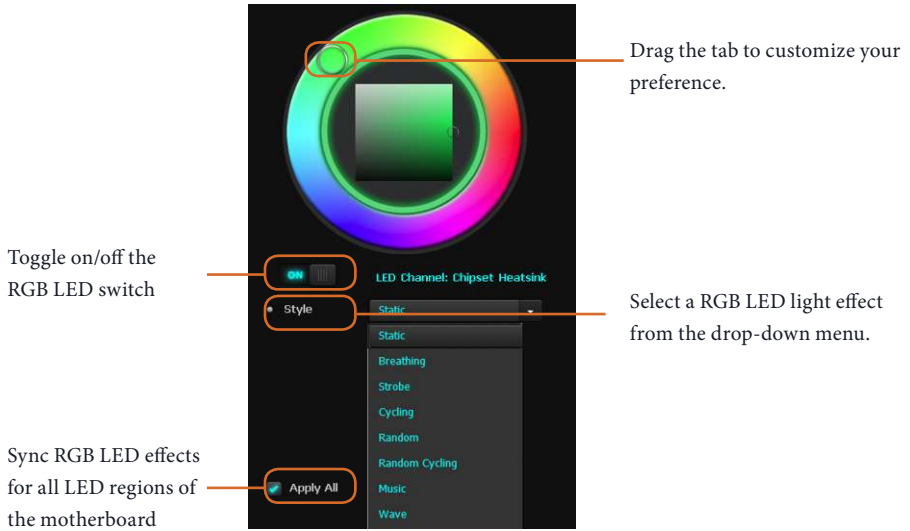

Chapter 4 UEFI SETUP UTILITY

4.1 Introduction

This section explains how to use the UEFI SETUP UTILITY to configure your system. You may run the UEFI SETUP UTILITY by pressing <F2> or right after you power on the computer, otherwise, the Power-On-Self-Test (POST) will continue with its test routines. If you wish to enter the UEFI SETUP UTILITY after POST, restart the system by pressing <Ctl> + <Alt> + <Delete>, or by pressing the reset button on the system chassis. You may also restart by turning the system off and then back on.



Because the UEFI software is constantly being updated, the following UEFI setup screens and descriptions are for reference purpose only, and they may not exactly match what you see on your screen.

4.2 EZ Mode

The EZ Mode screen appears when you enter the BIOS setup program by default. EZ mode is a dashboard which contains multiple readings of the system's current status. You can check the most crucial information of your system, such as CPU speed, DRAM frequency, SATA information, fan speed, etc.

Press <F6> or click the "Advanced Mode" button at the upper right corner of the screen to switch to "Advanced Mode" for more options.



No.	Function
1	Help
2	Load UEFI Defaults
3	Save Changes and Exit
4	Discard Changes
5	Change Language
6	Switch to Advanced Mode

4.3 Advanced Mode

The Advanced Mode provides more options to configure the BIOS settings. Refer to the following sections for the detailed configurations.

To access the EZ Mode, press <F6> or click the "EZ Mode" button at the upper right corner of the screen.

4.3.1 UEFI Menu Bar

The top of the screen has a menu bar with the following selections:

Main	For setting system time/date information
OC Tweaker	For overclocking configurations
Advanced	For advanced system configurations
Tool	Useful tools
H/W Monitor	Displays current hardware status
Boot	For configuring boot settings and boot priority
Security	For security settings
Exit	Exit the current screen or the UEFI Setup Utility

4.3.2 Navigation Keys

Use <←> key or <→> key to choose among the selections on the menu bar, and use <↑> key or <↓> key to move the cursor up or down to select items, then press <Enter> to get into the sub screen. You can also use the mouse to click your required item.

Please check the following table for the descriptions of each navigation key.

Navigation Key(s)	Description
+ / -	To change option for the selected items
<Tab>	Switch to next function
<PGUP>	Go to the previous page
<PGDN>	Go to the next page
<HOME>	Go to the top of the screen
<END>	Go to the bottom of the screen
<F1>	To display the General Help Screen
<F5>	Add / Remove Favorite
<F6>	Enter / Exit EZ Mode
<F7>	Discard changes and exit the SETUP UTILITY
<F9>	Load optimal default values for all the settings
<F10>	Save changes and exit the SETUP UTILITY
<F12>	Print screen
<ESC>	Jump to the Exit Screen or exit the current screen

4.4 Main Screen

When you enter the UEFI SETUP UTILITY, the Main screen will appear and display the system overview.



Favorite

Display your collection of BIOS items. Press F5 to add/remove your favorite items.

4.5 OC Tweaker Screen

In the OC Tweaker screen, you can set up overclocking features.



Because the UEFI software is constantly being updated, the following UEFI setup screens and descriptions are for reference purpose only, and they may not exactly match what you see on your screen.

Advanced Turbo

You can use this option to increase your system performance. This option appears only when your CPU supports this function. This option appears only when you adopt K-Series CPU.

Load Optimized CPU OC Setting

You can use this option to load optimized CPU overclocking setting. Please note that overclocking may cause damage to your CPU and motherboard. It should be done at your own risk and expense.

CPU Configuration

Per Core Mode

Per core mode is disabled by default.

CLR Max Ratio

Sets the maximum OC Ratio for the CLR Domain.

CLR Min Ratio

Sets the minimum OC Ratio for the CLR Domain.

Flex Ratio

Sets the value for the CPU Flex Ratio.

BCLK Frequency

The CPU speed is determined by the CPU Ratio multiplied with the BCLK. Increasing the BCLK will increase the internal CPU clock speed but also affect the clock speed of other components.

BCLK Step

The CPU speed is determined by the CPU Ratio multiplied with the BCLK. Increasing the BCLK will increase the internal CPU clock speed but also affect the clock speed of other components.

BCLK Reset Range

Configure the BCLK Reset Range. Issue a reset when BCLK overclocking exceed this range.

Stable Delay

Configure the delay time after BCLK settings for stable signals.

CPU PLL Spread Spectrum

Enable CPU PLL Spread Spectrum to reduce electromagnetic interference for passing EMI tests. Disable to achieve higher clock speeds when overclocking.

SRC PLL Spread Spectrum

Enable SRC PLL Spread Spectrum to reduce electromagnetic interference for passing EMI tests. Disable to achieve higher clock speeds when overclocking.

CPU BCLK Amplitude

Configure the BCLK Amplitude for ClockGen.

SRC BCLK Amplitude

Configure the BCLK Amplitude for SRC.

SATA BCLK Amplitude

Configure the BCLK Amplitude for SATA.

CPU1 Slew Rate

Configure the CPU Slew Rate. Adjust the BCLK signal by defining the maximum change rate of the output voltage. Higher value will result in a shorter signal rising time.

CPU2/SRC1 Slew Rate

Configure the CPU2/SRC1 Slew Rate. Adjust the BCLK signal by defining the maximum change rate of the output voltage. Higher value will result in a shorter signal rising time.

SRCO Slew Rate

Configure the SRCO Slew Rate. Adjust the BCLK signal by defining the maximum change rate of the output voltage. Higher value will result in a shorter signal rising time.

SATA Slew Rate

Configure the SRCO Slew Rate. Adjust the BCLK signal by defining the maximum change rate of the output voltage. Higher value will result in a shorter signal rising time.

CPU PLL ORT

Configure the CPU PLL ORT. Overshoot Reduction Technology improves the BCLK signal to decrease overshoot/undershoot.

PCIE PLL ORT

Configure the PCIE PLL ORT. Overshoot Reduction Technology improves the BCLK signal to decrease overshoot/undershoot.

CPU Output Divider

Configure the CPU output divider.

SRC Output Divider

Configure the SRC output divider.

PCIE PLL Divider

Configure the PCIE PLL divider.

SRCO Source

Select CPU PLL or PCIE PLL as the CPU2/SRC1 source.

ClockGen Delay

Configure the delay at the beginning of Clockgen.

ClockGen GPIO

Configure the General-purpose input/output (GPIO) at the beginning of Clockgen.

Boot Performance Mode

Select the performance state that the BIOS will set before OS handoff.

FCLK Frequency

Configure the FCLK Frequency.

Intel Turbo Boost Technology

Intel Turbo Boost Technology enables the processor to run above its base operating frequency when the operating system requests the highest performance state.

Intel SpeedStep Technology

Intel SpeedStep technology allows processors to switch between multiple frequencies and voltage points for better power saving and heat dissipation.

Intel Speed Shift Technology

Enable/Disable Intel Speed Shift Technology support. Enabling will expose the CPPC v2 interface to allow for hardware controlled P-states.

MFC Mode Override

Configure the MFC Mode Override.

Adjust Pll

Adjust the Pll for higher -BCLK ration combination.

Pll Trim

Adjust the Pll value between +63 ro -63.

Pll Trim Prefix

Adjust the Pll Trim Prefix.

Change MC-PLL Trim Value

Adjust the MC-PLL value between +63 to -63.

Change MC-PLL Trim Prefix

Adjust the MC-PLL Trim Prefix.

TJ-Max offset

Adjust the TJ-Max offset.

DCST LUT0

Configure the DCST LUT0.

DCST LUT1

Configure the DCST LUT1.

DCST LUT2

Configure the DCST LUT2.

DCST LUT3

Configure the DCST LUT3.

AVX2 Negative Offset

AVX2 Negative Offset reduces core frequency. The AVX2 Negative Offset specifies a negative offset from the Turbo Ratio Limit for AVX2 workloads.

AVX3 Negative Offset

AVX3 Negative Offset reduces core frequency. The AVX3 Negative Offset specifies a negative offset from the Turbo Ratio Limit for AVX3 workloads.

Current Limit

Configure the current limit of the CPU under Turbo Mode in ampere. A lower limit can protect the CPU and save power, while a higher limit may improve performance.

Long Duration Power Limit

Configure Package Power Limit 1 in watts. When the limit is exceeded, the CPU ratio will be lowered after a period of time. A lower limit can protect the CPU and save power, while a higher limit may improve performance.

Long Duration Maintained

Configure the period of time until the CPU ratio is lowered when the Long Duration Power Limit is exceeded.

Short Duration Power Limit

Configure Package Power Limit 2 in watts. When the limit is exceeded, the CPU ratio will be lowered immediately. A lower limit can protect the CPU and save power, while a higher limit may improve performance.

DRAM Configuration

DRAM Tweaker

Fine tune the DRAM settings by leaving marks in checkboxes. Click OK to confirm and apply your new settings.

DRAM Timing Configuration

Load XMP Setting

Load XMP settings to overclock the DDR memory and perform beyond standard specifications.

BCLK Frequency

The CPU speed is determined by the CPU Ratio multiplied with the BCLK. Increasing the BCLK will increase the internal CPU clock speed but also affect the clock speed of other components.

DRAM Frequency

If [Auto] is selected, the motherboard will detect the memory module(s) inserted and assign the appropriate frequency automatically.

DRAM Reference Clock

Select Auto for optimized settings.

Primary Timing

CAS# Latency (tCL)

The time between sending a column address to the memory and the beginning of the data in response.

RAS# to CAS# Delay (tRCD)

RAS# to CAS# Delay : The number of clock cycles required between the opening of a row of memory and accessing columns within it.

Row Precharge (tRP)

Row Precharge: The number of clock cycles required between the issuing of the precharge command and opening the next row.

RAS# Active Time (tRAS)

The number of clock cycles required between a bank active command and issuing the precharge command.

Command Rate (CR)

The delay between when a memory chip is selected and when the first active command can be issued.

Secondary Timing

Write Recovery Time (tWR)

The amount of delay that must elapse after the completion of a valid write operation, before an active bank can be precharged.

Refresh Cycle Time (tRFC)

The number of clocks from a Refresh command until the first Activate command to the same rank.

RAS to RAS Delay (tRRD)

The number of clocks between two rows activated in different banks of the same rank.

RAS to RAS Delay (tRRD_L)

The number of clocks between two rows activated in different banks of the same rank.

Write to Read Delay (tWTR)

The number of clocks between the last valid write operation and the next read command to the same internal bank.

Write to Read Delay (tWTR_L)

The number of clocks between the last valid write operation and the next read command to the same internal bank.

Read to Precharge (tRTP)

The number of clocks that are inserted between a read command to a row pre-charge command to the same rank.

Four Activate Window (tFAW)

The time window in which four activates are allowed the same rank.

CAS Write Latency (tCWL)

Configure CAS Write Latency.

Third Timing

tREFI

Configure refresh cycles at an average periodic interval.

tCKE

Configure the period of time the DDR4 initiates a minimum of one refresh command internally once it enters Self-Refresh mode.

tCCD

Configure back to back CAS to CAS (i.e. READ to RAED or WRITE to WRITE) from same rank separation parameter.

tCCD_L

Configure back to back CAS to CAS (i.e. READ to RAED or WRITE to WRITE) from same rank separation parameter.

tCCD_WR_L

Configure back to back CAS to CAS (i.e. READ to RAED or WRITE to WRITE) from same rank separation parameter.

tRRDS

The number of clocks between two rows activated in different banks of the same rank.

tRRDR

Configure Read to Read different rank dead cycle Back to back READ to WRITE from different DIMM separation parameter.

tRRDD

Use this item to change tRRDD setting. The default is [Auto].

tRWSR

Use this item to change tRWSR setting. The default is [Auto].

tRWDS

Use this item to change tRWDS setting. The default is [Auto].

tRWDR

Use this item to change tRWDR setting. The default is [Auto].

tRWDD

Use this item to change tRWDD setting. The default is [Auto].

tWRDS

Use this item to change tWRDS setting. The default is [Auto].

tWRDR

Use this item to change tWRDR setting. The default is [Auto].

tWRDD

Use this item to change tWRDD setting. The default is [Auto].

tWWDS

Use this item to change tWWDS setting. The default is [Auto].

tWWDR

Use this item to change tWWDR setting. The default is [Auto].

tWWDD

Use this item to change tWWDD setting. The default is [Auto].

Advanced Setting

ODT WR (A1)

Configure the memory on die termination resistors' WR for channel A1.

ODT WR (A2)

Configure the memory on die termination resistors' WR for channel A2.

ODT WR (B1)

Configure the memory on die termination resistors' WR for channel B1.

ODT WR (B2)

Configure the memory on die termination resistors' WR for channel B2.

ODT WR (C1)

Configure the memory on die termination resistors' WR for channel C1.

ODT WR (C2)

Configure the memory on die termination resistors' WR for channel C2.

ODT WR (D1)

Configure the memory on die termination resistors' WR for channel D1.

ODT WR (D2)

Configure the memory on die termination resistors' WR for channel D2.

ODT PARK (A1)

Configure the memory on die termination resistors' PARK for channel A1.

ODT PARK (A2)

Configure the memory on die termination resistors' PARK for channel A2.

ODT PARK (B1)

Configure the memory on die termination resistors' PARK for channel B1.

ODT PARK (B2)

Configure the memory on die termination resistors' PARK for channel B2.

ODT PARK (C1)

Configure the memory on die termination resistors' PARK for channel C1.

MRC Promote Warnings

Determines if MRC warnings are promoted to system level.

Promote Warnings

Determines if warnings are promoted to system level.

Halt on mem Training Error

Use this item to enable or disable Halt on memory Training Error.

Memory Test

Use this item to enable or disable memory test during normal boot.

MemTestLoops

Set the number of memory test loops during normal boot.

Memory Test On Fast Boot

Use this item to enable or disable memory test during fast boot.

Attempt Fast Boot

Use this item to enable or disable memory test during fast boot.

Attempt Fast Cold Boot

When enabled, portions of memory reference code will be skipped when it is possible to increase boot speed.

Voltage Configuration

CPU Vcore Voltage

Configure the voltage for the CPU Vcore.

CPU Load-Line Calibration

CPU Load-Line Calibration helps prevent CPU voltage droop when the system is under heavy loading.

VPPM AB Voltage

Configure the voltage for the VPPM AB.

DRAM AB Voltage

Configure the voltage for the DRAM AB.

VTTM AB Voltage

Configure the voltage for the VTTM AB.

VPPM CD Voltage

Configure the voltage for the VPPM CD.

DRAM CD Voltage

Configure the voltage for the DRAM CD.

VTTM CD Voltage

Configure the voltage for the VTTM CD.

1.0 PCH Voltage

Configure the chipset voltage (1.0V).

PCH PLL Voltage

PCH PLL voltage helps BCLK overclocking, also slightly improves memory overclocking.

VCCIO Voltage

Configure the voltage for the VCCIO.

CPU PLL1 Voltage

Configure the voltage for the CPU PLL1.

CPU PLL1 Eventual Voltage

Configure the voltage for the eventual CPU PLL1.

CPU PLL2 Voltage

Configure the voltage for the CPU PLL2.

CPU PLL2 Eventual Voltage

Configure the voltage for the eventual CPU PLL2.

Cold Bug Killer

Cold Bug Killer Voltage. Recommended to set 2.200V~2.400V for Ln2benching. It will solve most of CPU cold bug.

VCCSA Voltage

Configure the voltage for the VCCSA.

VCC PPL Voltage

VCC PLL helps BCLK overclocking. Also this voltage rail is input source of CPU internal PLL voltage. Please set this voltage as 1.400V~1.500V when CPU is under LN2 benching. Very few CPU requests 2.500V~2.800V to get rid of cold bug.

CLK VDD Voltage

Configure the voltage for the CLK VDD.

CPU Internal PLL Voltage

Default is 0.900V. Each step is 0.015V. Adding 9- 15 steps will help CPU PLL to lock internal clock during High frequency under Ln2 cooling. For example: 1.020V -1.125V will be proper value. But the voltage level will be different on each processor. User has to find the best value for your own processor. CPU Vcore Voltage must be higher than CPU Internal PLL Voltage, or your processor will hang.

CPU Core AC LoadLine

AC Loadline defined in 1/100 mOhms. A value of 100 = 1.00 mOhm, and 1255 = 12.55 mOhm. Range is 0-6249 (0-62.49 mOhms). 0 = AUTO/HW default. Uses BIOS mailbox command 0x2.

CPU Core DC LoadLine

DC Loadline defined in 1/100 mOhms. A value of 100 = 1.00 mOhm, and 1255 = 12.55 mOhm. Range is 0-6249 (0-62.49 mOhms). 0 = AUTO/HW default. Uses BIOS mailbox command 0x2.

CPU Vcore PWM Switching Frequency

Configure the PWM switching frequency for CPU Vcore.

VCCSA PWM Switching Frequency

Configure the PWM switching frequency for VCCSA.

Vcore/VCCSA OVP

Configure the Vcore/VCCSA OVP.

Vcore/VCCSA OCP

Configure the Vcore/VCCSA OCP.

Vcore/VCCSA UVP

Configure the Vcore/VCCSA UVP.

CPU Vcore Per-Phase OCP

Configure the Per-Phase OCP for CPU Vcore.

VCCSA Per-Phase OCP

Configure the Per-Phase OCP for VCCSA.

Isense Gain

Configure the Isense Gain.

VCCIO PWM Switching Frequency

Configure the PWM switching frequency for VCCIO PWM.

PWM2 OVP

Configure the OVP for PWM2.

PWM2 OCP

Configure the OCP for PWM2.

PWM2 UVP

Configure the UVP for PWM2.

VCCIO Per-Phase OCP

Configure the Per-Phase OCP for VCCIO.

DRAM Voltage CD PWM Switching Frequency

Configure the PWM switching frequency for DRAM voltage on channel C, D.

PWM3 OVP

Configure the OVP for PWM3.

PWM3 OCP

Configure the OCP for PWM3.

PWM3 UVP

Configure the UVP for PWM3.

DRAM Voltage AB Per-Phase OCP

Configure the Per-Phase OCP for DRAM voltage on channel A, B.

DRAM Voltage CD Per-Phase OCP

Configure the Per-Phase OCP for DRAM voltage on channel C, D.

DRAM Voltage AB PWM Switching Frequency

Configure the PWM switching frequency for DRAM voltage on channel A, B.

FIVR Configuration

Core Voltage Mode

Selects between Adaptive and Override Voltage modes. In Override Mode, the voltage selected will be applied over all operating frequencies. In Adaptive mode, the voltage is interpolated only in turbo mode.

Core Voltage Override.

Specifies the Override Voltage applied to the IA Core domain. This voltage is specified in millivolts.

Core Extra Turbo Voltage

Specifies the extra turbo voltage applied while the IA Core is operating in turbo mode.

Core Voltage Offset

Specifies the offset voltage applied to the IA Core domain. This voltage is specified in millivolts.

Offset Prefix

Sets the offset value as positive or negative.

CLR Voltage Mode

Selects between Adaptive and Override Voltage modes. In Override Mode the voltage selected will be applied over all operating frequencies. In Adaptive Mode the voltage is interpolated only in turbo mode.

CLR Voltage Override

Specifies the Override Voltage applied to the GT domain. This voltage is specified in millivolts.

CLR Extra Turbo Voltage

Specifies the extra turbo voltage applied while GT is operating in turbo mode. Unit is in millivolts.

CLR Voltage Offset

Specifies the Offset Voltage applied to the GT domain. This voltage is specified in millivolts.

Offset Prefix

Sets the offset value as positive or negative.

Uncore Voltage Offset

Specifies the Offset Voltage applied to the Uncore domain. This voltage is specified in millivolts.

Offset Prefix

Sets the offset value as positive or negative.

FIVR Faults

Enable/Disable FIVR Faults. When FIVR faults are disabled, OVP and OCP protection mechanism will be masked. This is a dangerous configuration and the risk of using it is assumed by the user.

FIVR Efficiency Management

FIVR efficiency management is good for power delivery efficiency, but it may be an impediment to proper power delivery control under overclocking, particularly BCLK overclocking.

SVID Support

Enable/Disable SVID. Disabling SVID disables input voltage overrides.

Save User Default

Type a profile name and press enter to save your settings as user default.

Load User Default

Load previously saved user defaults.

Save User UEFI Setup Profile to Disk

It helps you to save current UEFI settings as an user profile to disk

Load User UEFI Setup Profile from Disk

You can load previous saved profile from the disk

4.6 Advanced Screen

In this section, you may set the configurations for the following items: CPU Configuration, Chipset Configuration, Storage Configuration, Super IO Configuration, ACPI Configuration, USB Configuration and Trusted Computing.

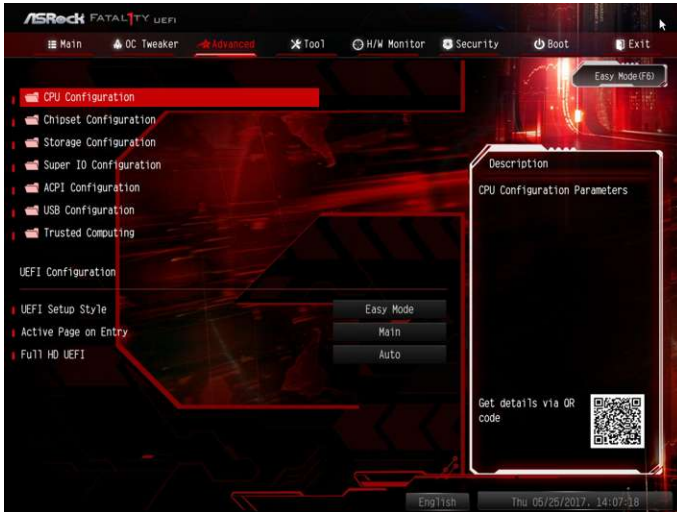

Setting wrong values in this section may cause the system to malfunction.

UEFI Configuration

UEFI Setup Style

Select the default mode when entering the UEFI setup utility.

Active Page on Entry

Select the default page when entering the UEFI setup utility.

Full HD UEFI

When [Auto] is selected, the resolution will be set to 1920 x 1080 if the monitor supports Full HD resolution. If the monitor does not support Full HD resolution, then the resolution will be set to 1024 x 768. When [Disable] is selected, the resolution will be set to 1024 x 768 directly.

4.6.1 CPU Configuration



Hyper Threading Technology

Intel Hyper Threading Technology allows multiple threads to run on each core, so that the overall performance on threaded software is improved.

Active Processor Cores

Select the number of cores to enable in each processor package.

CPU C States Support

Enable CPU C States Support for power saving. It is recommended to keep C3, C6 and C7 all enabled for better power saving.

Enhanced Halt State (C1E)

Enable Enhanced Halt State (C1E) for lower power consumption.

CPU C6 State Support

Enable C6 deep sleep state for lower power consumption.

Package C State Support

Enable CPU, PCIe, Memory, Graphics C State Support for power saving.

CFG Lock

This item allows you to disable or enable the CFG Lock.

CPU Thermal Throttling

Enable CPU internal thermal control mechanisms to keep the CPU from overheating.

Intel Virtualization Technology

Intel Virtualization Technology allows a platform to run multiple operating systems and applications in independent partitions, so that one computer system can function as multiple virtual systems.

Intel Safer Mode Extensions (SMX)

Enable/disable the Intel SMX (Safer Mode Extensions).

Hardware Prefetcher

Automatically prefetch data and code for the processor. Enable for better performance.

Adjacent Cache Line Prefetch

Automatically prefetch the subsequent cache line while retrieving the currently requested cache line. Enable for better performance.

4.6.2 Chipset Configuration

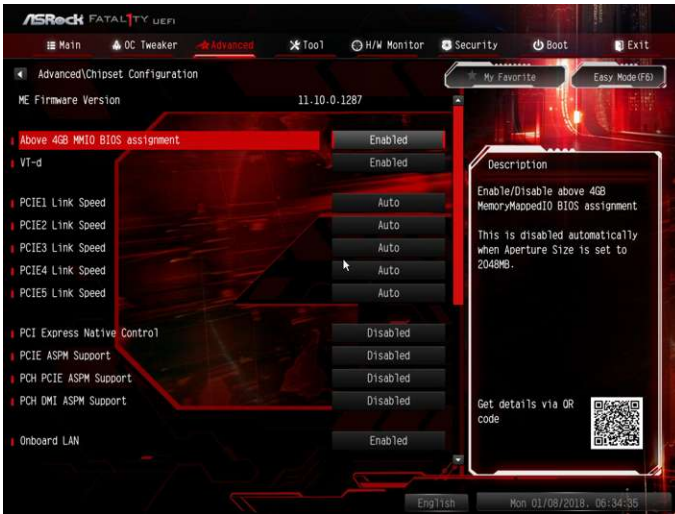

Above 4GB MMIO BIOS Assignment

Enable/disable above 4GB MemoryMappedIO BIOS assignment. This is disabled automatically when Aperture Size is set to 2048MB.

VT-d

Intel® Virtualization Technology for Directed I/O helps your virtual machine monitor better utilize hardware by improving application compatibility and reliability, and providing additional levels of manageability, security, isolation, and I/O performance.

PCIe1 Link Speed

Select the link speed for PCIe1.

PCIe2 Link Speed

Select the link speed for PCIe2.

PCIe3 Link Speed

Select the link speed for PCIe3.

PCIe4 Link Speed

Select the link speed for PCIe4.

PCIE5 Link Speed

Select the link speed for PCIE5.

PCI Express Native Control

Select Enable for enhanced PCI Express power saving in OS.

PCIE ASPM Support

This option enables/disables the ASPM support for all CPU downstream devices.

PCH PCIE ASPM Support

This option enables/disables the ASPM support for all PCH PCIE devices.

PCH DMI ASPM Support

This option enables/disables the ASPM support for all PCH DMI devices.

Onboard LAN

Enable or disable the onboard network interface controller.

Inte(R) Ethernet Connection I211AT

Enable or disable the onboard network interface controller (Intel® I211AT).

AQUANTIA 10G LAN

Enable or disable the onboard network interface controller (AQUANTIA 10G LAN).

Onboard HD Audio

Enable/disable onboard HD audio. Set to Auto to enable onboard HD audio and automatically disable it when a sound card is installed.

Front Panel

Enable/disable front panel HD audio.

WAN Radio

Enable/disable the WiFi module's connectivity.

Deep Sleep

Configure deep sleep mode for power saving when the computer is shut down.

Restore on AC/Power Loss

Select the power state after a power failure. If [Power Off] is selected, the power will remain off when the power recovers. If [Power On] is selected, the system will start to boot up when the power recovers.

Turn On LED in S5

Turn on/off the LED in the ACPI S5 state.

Onboard Debug Port LED

Enable/disable the onboard Dr. Debug LED.

4.6.3 Storage Configuration

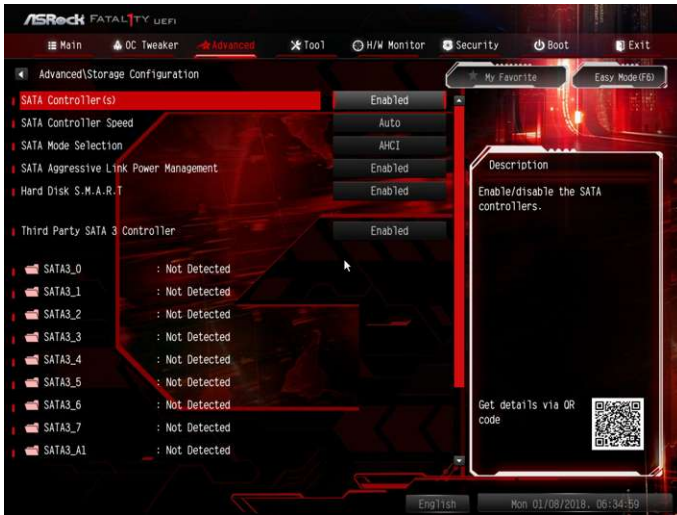

SATA Controller(s)

Enable/disable the SATA controllers.

SATA Controller Speed

Indicates the maximum speed the SATA controller can support.

SATA Mode Selection

[AHCI]: Supports new features that improve performance.

[RAID]: Combine multiple disk drives into a logical unit.

Alternate ID

Alternate ID allows you to enable or disable the report for the alternate device ID.

[Enabled]: Enable the RSTe (Rapid Storage Technology enterprise) feature.

[Disabled]: Enable the RST (Rapid Storage Technology) feature.

*Please note that if you install CPU with 44 lanes or 28 lanes, RSTe does not support PCH PCIe NVME and VROC (Intel® Virtual RAID on CPU) is supported.

SATA Aggressive Link Power Management

SATA Aggressive Link Power Management allows SATA devices to enter a low power state during periods of inactivity to save power. It is only supported by AHCI mode.

Hard Disk S.M.A.R.T.

S.M.A.R.T stands for Self-Monitoring, Analysis, and Reporting Technology. It is a monitoring system for computer hard disk drives to detect and report on various indicators of reliability.

Third Party SATA3 Controller

Enable or disable the third party SATA3 controller.

4.6.4 Super IO Configuration

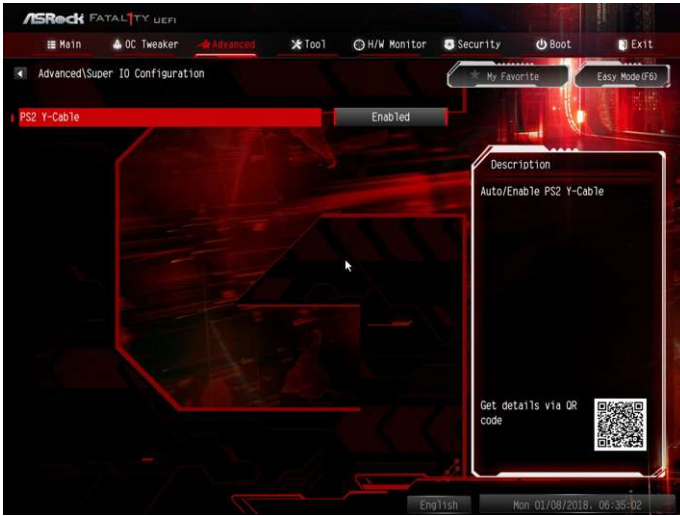

PS2 Y-Cable

Enable the PS2 Y-Cable or set this option to Auto.

4.6.5 ACPI Configuration

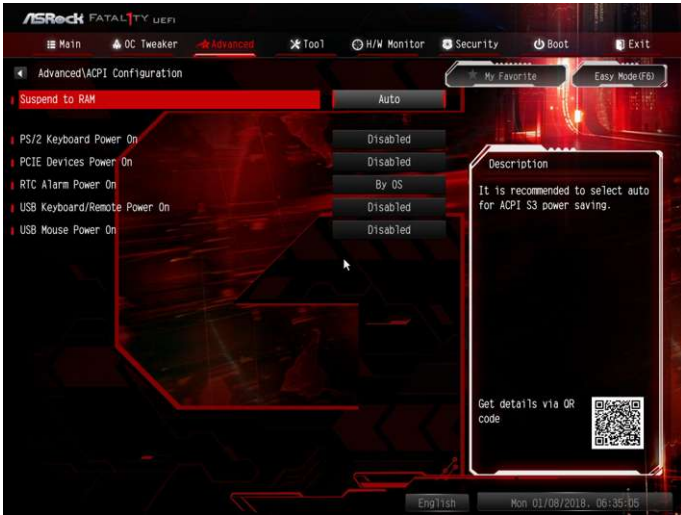

Suspend to RAM

Select disable for ACPI suspend type S1. It is recommended to select auto for ACPI S3 power saving.

PS/2 Keyboard Power On

Allow the system to be waked up by a PS/2 Keyboard.

PCIE Devices Power On

Allow the system to be waked up by a PCIE device and enable wake on LAN.

RTC Alarm Power On

Allow the system to be waked up by the real time clock alarm. Set it to By OS to let it be handled by your operating system.

USB Keyboard/Remote Power On

Allow the system to be waked up by an USB keyboard or remote controller.

USB Mouse Power On

Allow the system to be waked up by an USB mouse.

4.6.6 USB Configuration

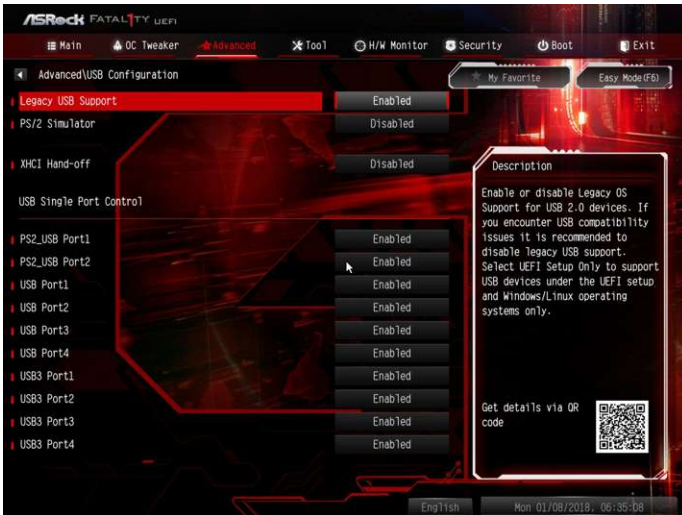

Legacy USB Support

Enable or disable Legacy OS Support for USB 2.0 devices. If you encounter USB compatibility issues it is recommended to disable legacy USB support. Select UEFI Setup Only to support USB devices under the UEFI setup and Windows/Linux operating systems only.

PS/2 Simulator

Enable PS/2 Simulator. This should be enabled for the complete USB keyboard legacy support for non-USB aware OSes.

*Enable this option if you install Windows 7.

XHCI Hand-off

This is a workaround for OSes without XHCI hand-off support. The XHCI ownership change should be claimed by XHCI driver.

4.6.7 Trusted Computing

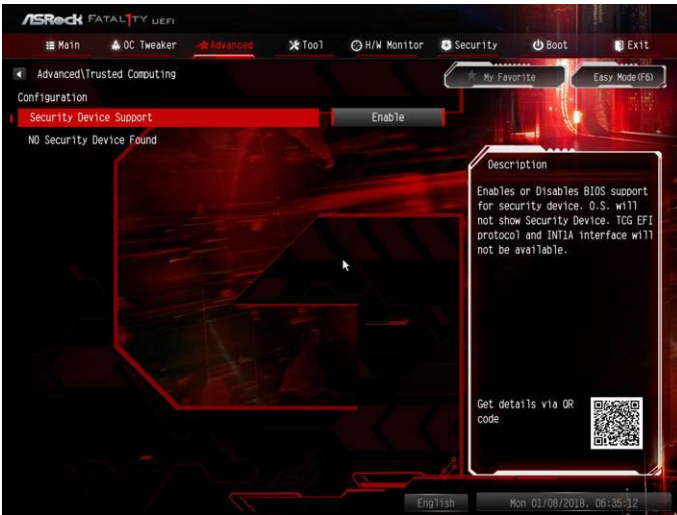

Security Device Support

Enable or disable BIOS support for security device.

4.7 Tools



UEFI Tech Service

Contact ASRock Tech Service if you are having trouble with your PC. Please setup network configuration before using UEFI Tech Service.

Easy RAID Installer

Easy RAID Installer helps you to copy the RAID driver from the support CD to your USB storage device. After copying the drivers please change the SATA mode to RAID, then you can start installing the operating system in RAID mode.

Instant Flash

Save UEFI files in your USB storage device and run Instant Flash to update your UEFI.

Internet Flash - DHCP (Auto IP), Auto

ASRock Internet Flash downloads and updates the latest UEFI firmware version from our servers for you. Please setup network configuration before using Internet Flash.

*For BIOS backup and recovery purpose, it is recommended to plug in your USB pen drive before using this function.

Secure Backup UEFI

Whenever one of the ROM images are outdated or corrupted, switch to the other flash ROM and execute Secure Backup UEFI to duplicate the current working ROM image to the secondary flash ROM.



This motherboard has two BIOS chips, an active BIOS (BIOS_A) and a backup BIOS (BIOS_B), which enhances the safety and stability of your system. Use "Secure Backup UEFI" to duplicate a working copy of the BIOS files to the active BIOS to ensure normal system operation. Normally, the system will work on the active BIOS. However if the active BIOS is corrupted or damaged, after several failed boot attempts, the backup BIOS will take over. For safety issues, users are not able to update the backup BIOS manually. Users may refer to the BIOS LEDs (BIOS_A_LED or BIOS_B_LED) to identify which BIOS is currently activated.

Network Configuration

Use this to configure internet connection settings for Internet Flash.

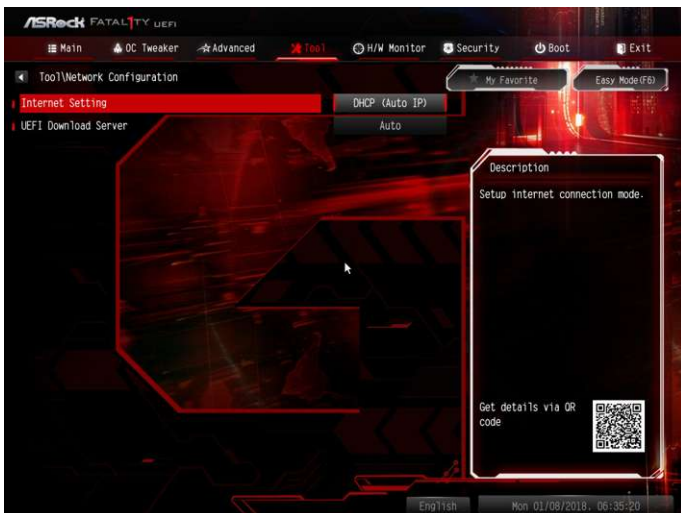

Internet Setting

Enable or disable sound effects in the setup utility.

UEFI Download Server

Select a server to download the UEFI firmware.

4.8 Hardware Health Event Monitoring Screen

This section allows you to monitor the status of the hardware on your system, including the parameters of the CPU temperature, motherboard temperature, fan speed and voltage.



Fan-Tastic Tuning

Select a fan mode for CPU Fans 1&2, or choose Customize to set 5 CPU temperatures and assign a respective fan speed for each temperature.

CPU Fan 1 Setting

Select a fan mode for CPU Fans 1, or choose Customize to set 5 CPU temperatures and assign a respective fan speed for each temperature.

CPU Fan Step Up

Set the value of CPU Fan Step Up.

CPU Fan Step Down

Set the value of CPU Fan Step Down.

CPU_OPT / W_Pump Switch

Select CPU Optional or Water Pump mode.

CPU Optional Fan Control Mode

Select PWM mode or DC mode for CPU Optional fan.

CPU Optional Fan Setting

Select a fan mode for CPU Optional fan, or choose Customize to set 5 CPU temperatures and assign a respective fan speed for each temperature.

CPU Optional Fan Temp Source

Select a fan temperature source for CPU Optional fan.

CPU Optional Fan Step Up

Set the value of CPU Optional fan Step Up.

CPU Optional Fan Step Down

Set the value of CPU Optional fan Step Down.

Chassis Fan 1 Setting

Select a fan mode for Chassis Fan 1, or choose Customize to set 5 CPU temperatures and assign a respective fan speed for each temperature.

Chassis Fan 1 Temp Source

Select a fan temperature source for Chassis Fan 1.

Chassis Fan 1 Step Up

Set the value of Chassis Fan 1 Step Up.

Chassis Fan 1 Step Down

Set the value of Chassis Fan 1 Step Down.

Chassis Fan 2 Setting

Select a fan mode for Chassis Fan 2, or choose Customize to set 5 CPU temperatures and assign a respective fan speed for each temperature.

Chassis Fan 2 Temp Source

Select a fan temperature source for Chassis Fan 2.

Chassis Fan 2 Step Up

Set the value of Chassis Fan 2 Step Up.

Chassis Fan 2 Step Down

Set the value of Chassis Fan 2 Step Down.

CHA_FAN3 / W_Pump Switch

Select CHA_FAN3/CPU Optional or Water Pump mode.

Chassis Fan 3 Control Mode

Select PWM mode or DC mode for Chassis Fan 3.

Chassis Fan 3 Setting

Select a fan mode for Chassis Fan 3, or choose Customize to set 5 CPU temperatures and assign a respective fan speed for each temperature.

Chassis Fan 3 Temp Source

Select a fan temperature source for Chassis Fan 3.

Chassis Fan 3 Step Up

Set the value of Chassis Fan 3 Step Up.

Chassis Fan 3 Step Down

Set the value of Chassis Fan 3 Step Down.

Over Temperature Protection

When Over Temperature Protection is enabled, the system automatically shuts down when the motherboard is overheated.

4.9 Security Screen

In this section you may set or change the supervisor/user password for the system. You may also clear the user password.

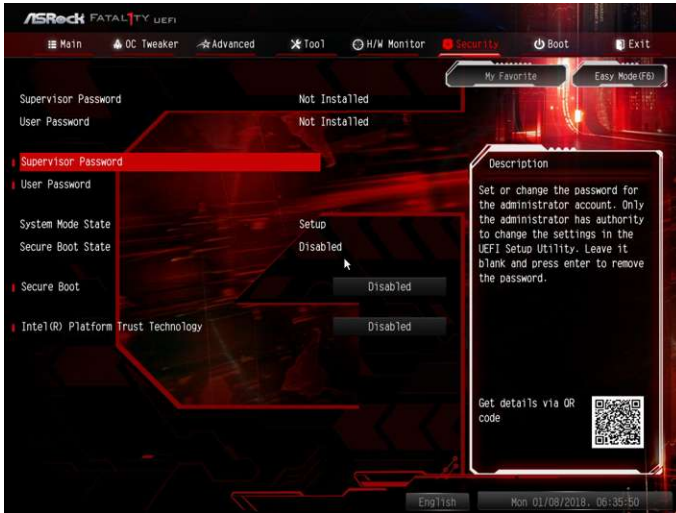

Supervisor Password

Set or change the password for the administrator account. Only the administrator has authority to change the settings in the UEFI Setup Utility. Leave it blank and press enter to remove the password.

User Password

Set or change the password for the user account. Users are unable to change the settings in the UEFI Setup Utility. Leave it blank and press enter to remove the password.

Secure Boot

Use this item to enable or disable support for Windows 8.1 Secure Boot.

Intel(R) Platform Trust Technology

Enable/disable Intel PTT in ME. Disable this option to use discrete TPM Module.

4.10 Boot Screen

This section displays the available devices on your system for you to configure the boot settings and the boot priority.

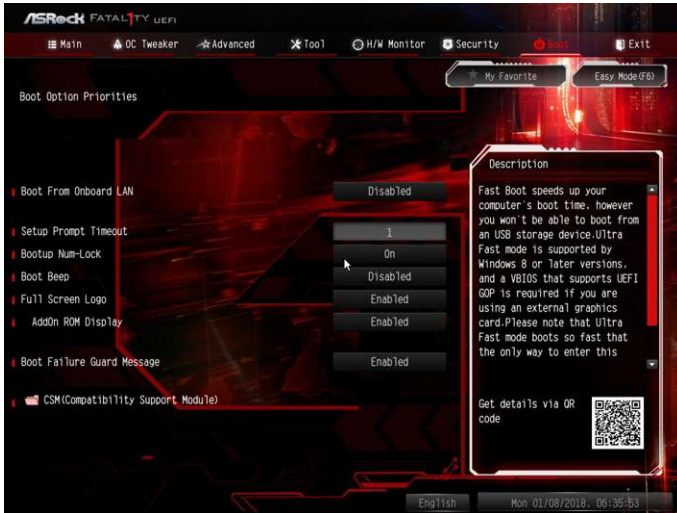

Boot From Onboard LAN

Allow the system to be waked up by the onboard LAN.

Setup Prompt Timeout

Configure the number of seconds to wait for the setup hot key.

Bootup Num-Lock

Select whether Num Lock should be turned on or off when the system boots up.

Boot Beep

Select whether the Boot Beep should be turned on or off when the system boots up. Please note that a buzzer is needed.

Full Screen Logo

Enable to display the boot logo or disable to show normal POST messages.

AddOn ROM Display

Enable AddOn ROM Display to see the AddOn ROM messages or configure the AddOn ROM if you've enabled Full Screen Logo. Disable for faster boot speed.

Boot Failure Guard Message

If the computer fails to boot for a number of times the system automatically restores the default settings.

CSM (Compatibility Support Module)

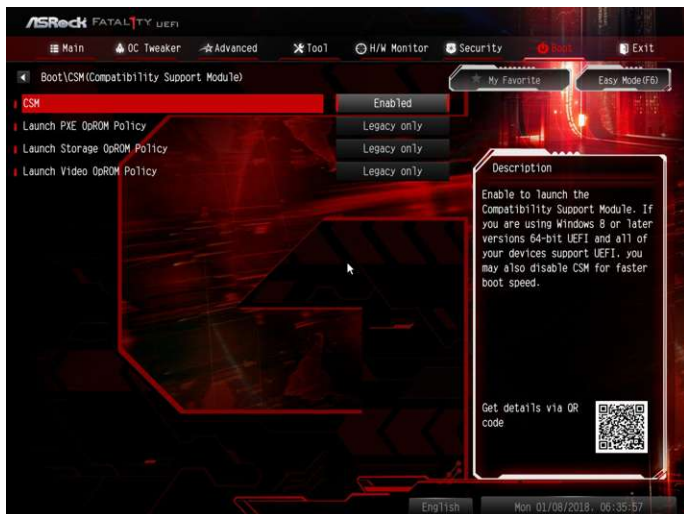

CSM

Enable to launch the Compatibility Support Module. Please do not disable unless you're running a WHCK test. If you are using Windows 8.1 64-bit and all of your devices support UEFI, you may also disable CSM for faster boot speed.

Launch PXE OpROM Policy

Select UEFI only to run those that support UEFI option ROM only. Select Legacy only to run those that support legacy option ROM only. Select Do not launch to not execute both legacy and UEFI option ROM.

Launch Storage OpROM Policy

Select UEFI only to run those that support UEFI option ROM only. Select Legacy only to run those that support legacy option ROM only. Select Do not launch to not execute both legacy and UEFI option ROM.

Launch Video OpROM Policy

Select UEFI only to run those that support UEFI option ROM only. Select Legacy only to run those that support legacy option ROM only. Select Do not launch to not execute both legacy and UEFI option ROM.

4.11 Exit Screen



Save Changes and Exit

When you select this option the following message, “Save configuration changes and exit setup?” will pop out. Select [OK] to save changes and exit the UEFI SETUP UTILITY.

Discard Changes and Exit

When you select this option the following message, “Discard changes and exit setup?” will pop out. Select [OK] to exit the UEFI SETUP UTILITY without saving any changes.

Discard Changes

When you select this option the following message, “Discard changes?” will pop out. Select [OK] to discard all changes.

Load UEFI Defaults

Load UEFI default values for all options. The F9 key can be used for this operation.

Launch EFI Shell from filesystem device

Copy shellx64.efi to the root directory to launch EFI Shell.

Contact Information

If you need to contact ASRock or want to know more about ASRock, you're welcome to visit ASRock's website at <http://www.asrock.com>; or you may contact your dealer for further information. For technical questions, please submit a support request form at <http://www.asrock.com/support/tsd.asp>

ASRock Incorporation

2F., No.37, Sec. 2, Jhongyang S. Rd., Beitou District,

Taipei City 112, Taiwan (R.O.C.)

ASRock EUROPE B.V.

Bijsterhuizen 11-11

6546 AR Nijmegen

The Netherlands

Phone: +31-24-345-44-33

Fax: +31-24-345-44-38

ASRock America, Inc.

13848 Magnolia Ave, Chino, CA91710

U.S.A.

Phone: +1-909-590-8308

Fax: +1-909-590-1026